

# Electronic Design®

# LIBRARY

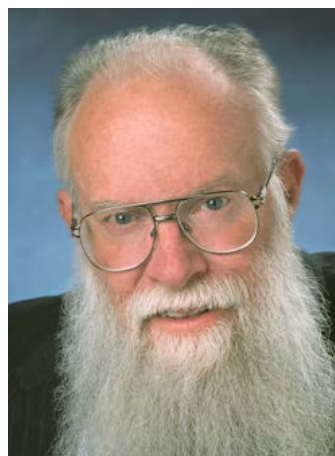

FOCUS ON:  
**BOB PEASE**  
**ON ANALOG** VOL. 1

A compendium of technical articles  
from legendary *Electronic Design*  
engineer Bob Pease



# CONTENTS

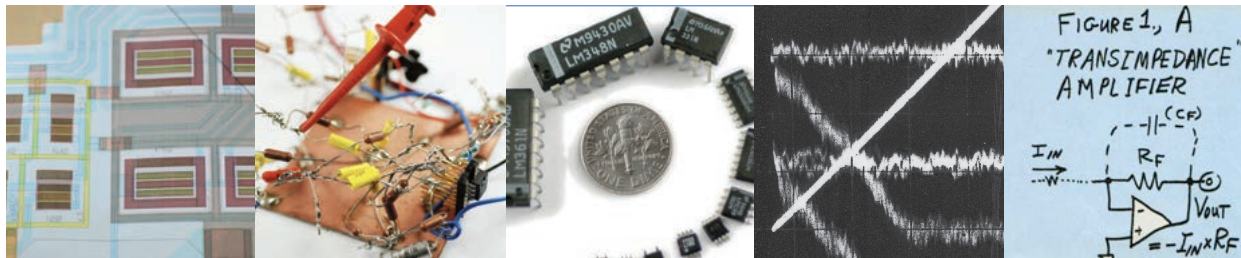

- 2** | Welcome
- 3** | Celebrating Bob Pease
- 6** | What's All This Designer Stuff, Anyhow?
- 11** | What's All This Analog Engineering Stuff, Anyhow?
- 17** | What's All This Technical Reading Stuff Anyhow?
- 25** | What's All This Transimpedance Amplifier Stuff, Anyhow?
- 33** | What's all This Frequency To Voltage Converter Stuff, Anyhow?
- 38** | What's All This Capacitor Leakage Stuff, Anyhow?
- 41** | What's All This Noise Gain Stuff, Anyhow?
- 44** | What's All This Current Limiter Stuff, Anyhow?
- 49** | What's All This Output Impedance Stuff, Anyhow? Part 1
- 52** | What's All This Output Impedance Stuff, Anyhow? Part 2
- 55** | More Resources From *Electronic Design*

EDITORIAL

**Electronic  
Design**

## Celebrating BOB PEASE

*Bob was a regular contributor to Electronic Design and he passed away in 2011. His writings continue to be highly respected and useful to today's developers.*

*To celebrate Bob's memory, Electronic Design has released a pair of ebooks featuring a collection of reader favorites. These articles are timeless and showcase why Bob Pease will always hold a revered place in the analog industry. We miss your wit and unabashed style of writing, Bob.*

*The Electronic Design Editorial Team*



## EDITORIAL

By Joe Desposito

former Editor-in-Chief | *Electronic Design**Originally published June 2011*

## Bob Pease Remembered For Pease Porridge And A Whole Lot More

It was late on Father's Day, around 11:55 p.m., when I finally got around to writing my editorial for this issue, which was due the next day. I had some ideas of what I wanted to write about and was busy gathering information. One piece of information I needed was in an e-mail I had received a couple of weeks ago, so I launched Microsoft Outlook.

Rather than going straight to the e-mail I needed, I started skimming the e-mails that had come in over the weekend. The first one I came across was a notice that my niece had wished me a happy Father's Day in a Facebook post. I clicked on the link, got on Facebook, and sent a reply. Then I went back to Outlook and continued skimming the e-mails. One subject line stopped me cold. It said, "Bob Pease Killed in Car Crash." I read it in stunned disbelief. I looked at the

sender: Paul Rako, the analog editor from *EDN*. It must be true, I thought. Horrible news, but true.

In part, Paul said that Bob was killed when his car left the road as he drove from Jim Williams' memorial service yesterday. It's doubly unfortunate that two of the greatest analog minds in the business passed in the same week. As it was earlier on the West Coast, Don Tuite was online and sending e-mails to our staff. He sent a link to a *San Jose Mercury News* article: "Driver, 70, Dies in Saratoga Crash."

The short article stated all the facts: A 70-year-old San Francisco man was killed after his car hit a tree in Saratoga on Saturday evening, according to the California Highway Patrol. The man was traveling eastbound on Pierce Road at an unknown speed when he failed to negotiate a curve to the left at about

5:45 p.m. The driver's 1969 Volkswagen Beetle veered to the right off of the roadway and crashed into a large tree on the right shoulder. The man was not wearing his seatbelt and it appears he was killed instantly.

Everyone who reads Pease Porridge knows that Bob drove a 1969 Beetle. Bob brought it up many times over the years and just recently in a popular column about unintended acceleration. Everyone knew this because Bob was unrivaled as a columnist in this industry. Though he was certainly an analog guru who could write about the nuances of a very difficult subject area, he also talked about everyday (and not so everyday) life situations.

Bob told me many times that his column was about thinking. Whenever he tackled a topic, he essentially welcomed readers into a dialogue about how to properly think about that topic, at least from Bob's point of view. But, if you wrote to him, he would always consider your point of view as well and tell you what he thought.

Bob was greatly saddened by the death of Jim Williams. As you may know, Jim died recently after a massive stroke. During the following days, Bob corresponded with me about Jim. In one e-mail, which I think says a lot about the way Bob thought and lived, he said: "Jim did write more huge SYMPHONIES of

big Apps. Systems. I wrote more small ones. We always had very similar ideas on helping Users with Analog problems: We never turned down a request for Analog help. We agreed on that." Then, Bob said: "I am very SCRUPULOUS about taking my 5 or 7.5 mg of Coumadin every day. I don't know if Jim was on Coumadin. Coumadin = Warfarin = Rat Poison, good for preventing Strokes."

Bob also asked me to reprint part of a column on doctoring that he had written years ago about how to tell if someone was having a stroke. This particular column, "What's All This Floobydust, Anyhow? (Part 14)," contains a section called DOCTORING STUFF, PART 4C—STROKE DIAGNOSIS.

In Bob's grief about Jim, his first thought was to let the readers of this magazine know how to tell if someone is having a stroke. He starts off the section of this column by writing: "Many people know that in case of a heart attack or stroke, it is very important to get the victim to medical care very quickly, within much less than an hour. But what do we know about diagnosing such an unhappy person?" And he goes on from there to impart his knowledge on this topic and hopefully help someone save a life someday.

Unfortunately, we now have to say goodbye to Bob and all the wisdom he so generously shared over so many

## Bob Pease Remembered

years writing for *Electronic Design*. He was a tremendous talent and we will miss him greatly. You can find his latest column in our July 7 issue.

You won't be surprised to learn that he had the drafts for number of future columns in the works in addition to his popular "Bob's Mailbox" collection of correspondence. We will work with his family

on bringing those columns to you in the future. We think he would have wanted you to read them. And finally, wherever he may be right now, I'm sure he's thinking about writing, "What's All This Car Crash Stuff, Anyhow?" ■

*to view this article online,  [click here](#)*

[Back to Table of Contents](#)



# What's All This Designer Stuff, Anyhow

*Originally published January 1995*

A little while ago, I ran across an article in *Trains* magazine (Oct. 1994, pp. 46-49) about “Martin Blomberg, designer extraordinaire.” What did Mr. Blomberg design—a snazzy engine paint job? A new Diesel engine? Nope. He designed the “Blomberg truck.” It’s an improved frame that goes under each end of an engine—a wheel assembly with two axles, four wheels, and two big 300-kW electric motors. The truck was designed by Mr. Blomberg for the Electro-Motive Corp., a subsidiary of General Motors Corp., in 1937. This was first used on a Demonstrator freight locomotive, which logged 83,000 miles on 20 railroads in 1939-1940, and was acclaimed

## What's All This Designer Stuff, Anyhow?

as a great success wherever it went. Blomberg's truck is still in use today on most of the GMC freight locomotives. I think that's pretty good for a piece of 1939 engineering.

Why was the Blomberg truck considered such a good design? Well, previously, diesel passenger engines ran on flexible six-wheel trucks with two traction motors. The middle axle carried weight, but was not available to be powered. The early Diesel-electric engines had rigid four-wheel trucks and were suitable for yard switchers, not for long-distance, high-speed freight hauling. They had as good stability and ride comfort as steam freight engines, but not much better. In the late 1930s, Diesel engineers had to plan new freight engines that could move freight at fairly high speeds—but put out more power and more tractive force than any passenger locomotive. In other words, they had to provide the advantages of all the old, slow diesel switcher engines—and the advantages of the sleek fast passenger engines—yet put out a lot more power.

Mr. Blomberg's new truck design did that. It put all the weight on the driving wheels without any unpowered axle. He provided a firm but flexible suspension, putting all the weight evenly on all four wheels. According to the article,

“He designed the truck with a minimum of assistance, for there were no others at EMC acquainted with truck design. Strain gauges were crude, and finite element analysis was decades away. The designer himself had to rely on fairly simple calculations and a strong sense of mechanical aptitude, with perhaps a little luck added.”

So, what kind of man was Martin Blomberg? “He could be very courteous, but his standard answer, if anyone approached his ‘territorial waters’ with a suggestion was, ‘Ve do it my vay.’” Does that sound like anybody you know?

Recently, I was trying to write down the Job Description for a Product Engineer. Just for the heck of it, I also wrote down, for comparison, a definition of a Design Engineer. There's a lot of similarity, a lot of overlap, except for one major difference: A good Design Engineer not only has to put together a lot of circuit functions, using known designs, but he also must know when existing designs aren't good enough, and when and how to make new circuits.

What is a “Designer”? Is he/she a person who designs circuits? Wears flamboyant clothing and plans the décor for a house or an office—or a locomotive? Designs the transmission or the grille for a new car? Well, yes, a designer can



## What's All This Designer Stuff, Anyway?

be any or all of these things. But after you learn how to analyze things and prove the feasibility of a design, it's also of great value to be able to invent new circuits—new designs. To do that, you have to be familiar with lots of old designs. You have to know what each old design did well, and what it did badly. Basically, you just have to KNOW a lot of old designs.

When I started designing discrete-component op amps in 1961, I studied every circuit I could lay my hands on—voltage regulators, vacuum-tube circuits, transistorized circuits. I used good old, proven circuits when I could and invented new ideas when the old ideas weren't good enough. As I said in my first column four whole years ago, “computers may be able to help you optimize a given design, but it is not necessarily helpful when the old design is not good enough.” Guys like Bob Widlar, Bob Dobkin, and many others knew how to innovate. I can't say I'm in the top echelon of innovators, but I know how to get a job done.

Note, you can learn a number of things in school, in college, but almost

nobody learns a lot of circuits—or a lot of anything in detail. In the old days, a person had to LEARN a lot of circuits to get his amateur radio license. But these days, learning about and understanding a number of radio circuits—receivers and transmitters—is no longer required.

**Guys like Bob Widlar, Bob Dobkin, and many others knew how to innovate. I can't say I'm in the top echelon of innovators, but I know how to get a job done.**

When I began to get interested in circuits around my senior year, when I got out of the Physics course and into EE, I got an appetite for learning a large number of circuits. I really got engrossed in this, as if it were a hobby. Only if you're REALLY interested in a field, like the most enthusiastic hobbyist, will you

learn all the history of design, so you can tell when you have to break new ground and invent new circuits. Most students never get that interested—they have to take a smattering of course on many different subjects to be able to graduate. That's not the kind of intensity you need to be a good designer.

In addition, when you're innovating, you must be good at circuit analysis so you can see problems, drawbacks, and limitations of new circuits. You must be good at this, by intuition or by quick analysis, so that you don't have to drag

## What's All This Designer Stuff, Anyhow?

every new circuit through a long, slow Spice analysis. Besides, as I've mentioned many times, Spice might tell you a circuit would not work even when it really does. You can't run every potentially good idea through Spice.

Recently, I was trying to design a low-power R-S flip-flop in a bipolar circuit. I invented about four designs. Each one looked pretty good until I really did a one-minute pencil-and-paper analysis. Blah. They would not work. I finally asked a buddy for advice. He told me about a circuit he had used. We couldn't use that one due to power-supply limitations. But, I modified that circuit to go with some low-voltage compactors I already had and everything clicked. I haven't even bothered to breadboard it, nor to Spice it, because I can see how it has to work, perfectly, using just a little pencil and paper.

Now, I try to avoid saying good or bad things about a competitor, so I won't. But I will mention something about a new design made by a kid engineer at National about 20 years ago. Once upon a time, we had an LM109, designed by Bob Widlar, and it was good for about 1.5 A at 5 V. We also had an LM140, designed by George Cleveland. It had a much smaller die size and would do at 1.5 A at room temperature,

but only 1 A at all temperatures.

It was designed to be competitive commercially, especially when competing with Fairchild's UA7805. Unlike the LM109, the LM140 came in several different voltages—5, 6, 8, 9, 10, 12, 15, 18, and 24 V. We knew that, obviously, customers needed various different output voltages.

About 1974, Bob Dobkin asked Brent Welling, the Manager of Marketing for Linear, "What if you could have an adjustable voltage regulator that you could adjust to any voltage from 1.2 V to 40 V?" Brent asked, "Will it cost more to manufacture than an LM140?" Answer, yes. So Brent said, "Well, then there will not be any possibility of significant sales."

I'm not exactly sure how we did it, but in those days at NSC, we didn't have "teams." We didn't exactly have consensus. We didn't always have harmony and sweetness and light. But we had ways of getting parts out. I wonder if we wouldn't be better off if we could reconstruct that..

Anyhow, Bob Dobkin convinced us to get the LM117 into production, and it was a big winner. Of course, the LM117 has never outsold that LM140 in number of chips sold, because the LM140 was quite adequate for simple requirements.

But the LM117 made a good profit because it made lots of customers happy in critical applications.

Why? Well, it had a BIGGER power transistor with more ballasting. So, you could get more power out of it, at higher voltages, without blowing it up. Some of NSC's competitors tried LM117's good control circuit. But they used a smaller power transistor so they could get a cheaper, smaller die. As a result, their "117s" blew up with minimum abuse. So the LM117 sold well, because it could really do things that competitors could not do.

Here's another quote from the *Trains*: "Blomberg's truck design has been able to withstand the far greater demands imposed by today's locomotives with their higher horsepower and increased tractive effort. It has been said that he was not as cost-conscious as he should have been, that his designs were heavier than necessary, and that he would not listen to others. Many people would gladly plead guilty to such criticisms if their designs could be as successful as Blomberg's." Ain't that what Dobkin did with his LM117?

What else should a designer do? He must not just think of how to meet specs—although that's important too. He/she must think like a customer (a

user) and see what will really make them happy—and avoid things that would make a customer unhappy. You have to put on a marketing hat to see what features will appeal to the customer. You have to close your eyes and think—"how can I write a data sheet that will have sex appeal to engineers?" And if you can think of an advertisement, so much the better!

You have to be careful not to build in features that are excessively hard or expensive to make in production. You have to plan that any necessary test can actually be done without a lot of wasted time and expense.

Obviously, in every field—in styling a car, in decorating a room or a building, in designing a nine-ton two-axle truck to carry freight engines—you have to think about all of these facets. A good designer neglects none of these. Yeah, a truism. But it is true.

Recently, some outstanding engineers were described by the publication *American Heritage of the Invention & Technology* as "bold, self-reliant, independent, secure, powerful, daring, resolute, and sometimes, arrogant and overbearing." So, what's new? ■

*RAP/Robert A. Pease/Engineer*

to view this article online,  [click here](#)

[Back to Table of Contents](#)



# What's All This Analog Engineering Stuff, Anyhow

*Originally published October 2008*

Don't get dismayed by the rise of digital technologies. Analog engineers are still critical members of any design team.

For many years, aficionados of digital circuits and computers have bragged that their rapid advances will leave all analog circuits lying in the dust. The analog business is shrinking, at least compared to the success of digital computers. Moore's law has made sure of that for many years. The tiny transistors are smaller and faster than ever, even if they can't stand off 5 V (*Fig. 1*).

The efforts of a team of digital men who engineered and fit together a few hundred transistors has given way to automated schemes to assemble

## What's All Analog Engineering Stuff, Anyhow?

many thousands, many millions, and now billions of transistors. Boy, every circuit must cost millions of bucks! That means every microprocessor or system-on-a-chip (SoC) must be very profitable! Right?

Wrong. It ignores the fact that several thousand digital transistors may now sell for less than a penny. Digital IC makers must give away a million transistors to make a few bucks. This isn't necessarily true for analog circuits. A couple dozen years ago, we handed out some license plate frames in Silicon Valley that said "One good op amp is worth 1000 microprocessors." We still believe that!

A digital computer can do some things by computing the facts it is told. But to perform a useful function, it often needs a good bit of analog information. It needs to get information from the world or from its user. It also needs to get this data from sensors, where the information is channeled through analog preamps and/or filters. Usually, analog engineers have to engineer these channels. A brute-force approach generally doesn't work.

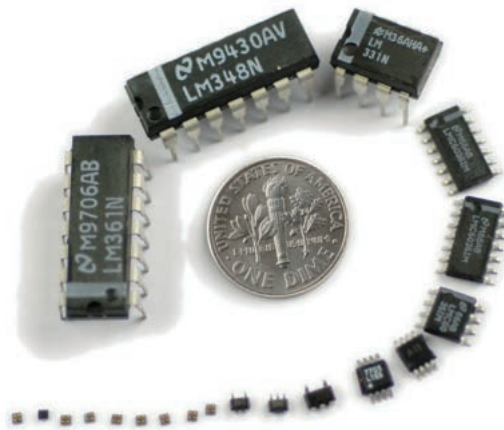

**1. The electronics industry has evolved as packages have gotten smaller and smaller. For example, the 14-pin dual-inline package (DIP) is now today's micro-SMD.**

Some sensors put out a signal that can be acquired directly by a fairly simple analog-to-digital converter (ADC) that interfaces to the sensor. But, typically, a high-performance ADC needs an anti-aliasing filter to prevent the sampling from turning high-frequency noises and spikes into low-frequency "artifacts."

What kind of filter is needed, and how many dB of attenuation are needed at the sampling frequency?

The person who designs that filter has to complete the filter engineering in the analog domain. You can't do it with digital signal processing (DSP). You must have a good analog filter before you get the information converted into signals that can be processed by DSP.

Now, in theory, it sounds like an ADC or digital-to-analog converter (DAC) will be designed by one analog group and one digital group that sit down, shake hands across a table, and figure out how to get their circuits to do a handshake, too (*Fig. 2*). But in practice, most high-performance ADCs are designed by analog engineers. They have to figure out how all of the signals and waveforms will get

along without causing trouble.

Yes, they do have to handle some digital signals, but that's not too hard. We analog engineers know how to handle "digital" signals without excessive bounce or overshoot! We know how to design and lay out transmission lines, terminated as needed.

Sure, some ADCs are integrated onto the main SoC, but these are mostly the low-performance (slow or low-resolution) ones. High-performance ones are usually done off-chip. They are often more cost-effective or time-effective.

Thus, analog circuits are also needed alongside modern microprocessors. Engineers used to try to add a lot of analog functions into the processor. But smaller feature sizes, faster logic, and low operating voltages have forced DIS-integration because a decent audio amplifier, low-noise preamp, bandgap reference, high-resolution ADC, or anti-aliasing filter can't be made (profitably or at all)

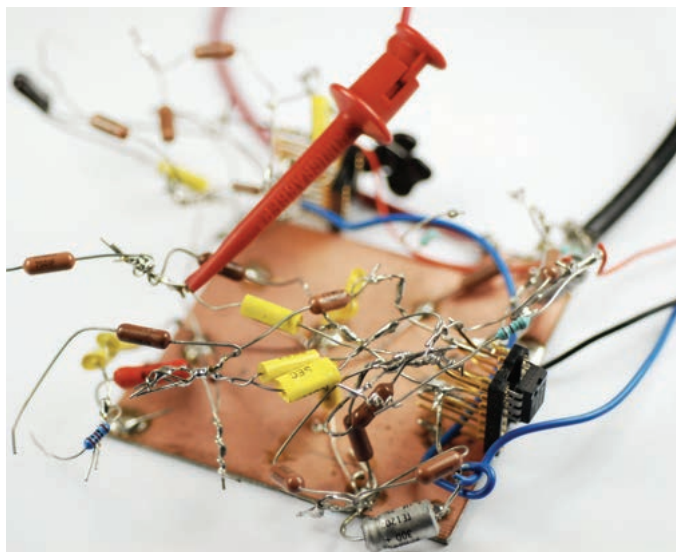

**2. It may look like a rat's nest, but this voltage-to-frequency converter was built over a ground plane using an LM331 and a couple of optional sizes of filter capacitor. That's how I usually wire up a breadboard. I never use a solderless breadboard. I built it to confirm that the LM331 still works just as well as it did when I first invented it 31 years ago.**

on such a low-voltage chip.

So, these functions are often being added as external chips. They don't hurt the yield, as they might if they're integrated on the main chip. They don't delay release of a system that is nearly finished. Mindless attempts at further integration have, in many cases, been replaced with disintegration.

There are still applications for digital computers, where most of the work is just computation. When the computing is all done, after a few hours, the computer spits out the answer: "42." But these days, there's often a lot of interaction between the user and the computer.

Sensors are needed. And, the sensor needs an ADC to convert the variable (force, position, pressure, temperature) into a digital format so the processor can figure out what to do with that information.

Temperature is one of the parameters that SoCs often try to sense. Sometimes

## What's All Analog Engineering Stuff, Anyhow?

the system wants to know the ambient temperature. Sometimes it also wants to know about the processor's temperature to help prevent overheating. It isn't impossible to do this with the temperature computation done on the main chip. However, it's usually better, cheaper, and easier to do it accurately with an external (disintegrated) temperature-measuring circuit off the main SoC.

This is often done with a remote diode temperature sensor (RDTS), which can sense temperature using almost any kind of stable diode or transistor. It can even sense the temperature of one transistor built into the middle of the main processor and, thus, protect it. Of course, detecting the ambient temp requires an off-chip sensor. Why not put the temp measuring function off-chip?

### **Voltage Regulator Stuff**

---

It's quite true that many CMOSICs can run on a wide range of power-supply voltages. So, you can get some things done by running them on a small battery. But modern high-performance CMOS circuits run fast on a low-voltage supply. If the battery voltage runs low, the CMOS runs slow, and the timing may suffer. If the battery gets too high, the CMOS starts to break down and overheat. So,

modern CMOS circuits need to run with a regulated supply.

Many low-dropout (LDO) regulators can run accurately on low voltages and regulate a battery source down to a lower voltage, but they generally aren't very efficient. LDOs often waste as much power as they put out. So while they are quite useful in some cases, they won't let you run your cellular phone for a long time. I mean, which would you buy—a cell phone or computer that runs for three hours or six hours?

That's why we need switch-mode regulators to get good efficiency. Aha! A switcher has drivers and power MOS-FETs that turn on and off—a bang-bang controller. That must be a good digital application!

But not at all. While the nominal voltage levels seem to be ones and zeros, the actual output voltage depends precisely on the time ratio or duty cycle of those apparently “bang-bang” signals. The duty cycle of these signals is an analog function and is controlled by an analog controller. So all computers these days run on regulated power, regulated by analog switch-mode controllers—controllers designed by analog designers.

The only digital things in those controllers are the techniques by which the fast duty-cycle signals are driven. And

## What's All Analog Engineering Stuff, Anyhow?

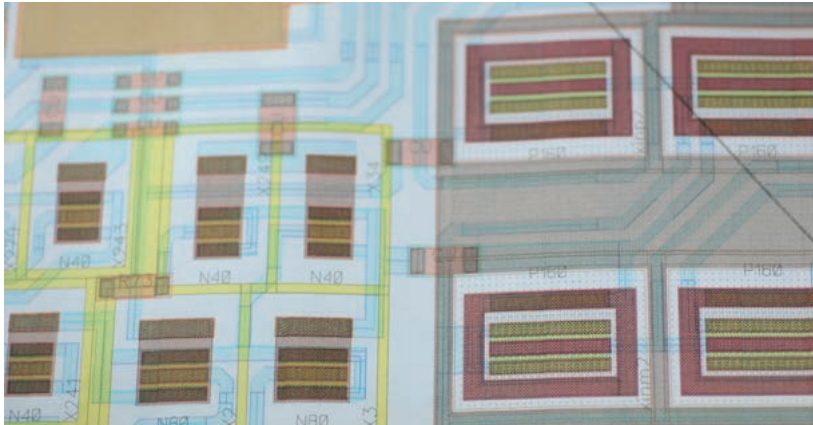

### 3. Op amps give designers lots of flexibility and can even lead to applications that the op-amp manufacturer never intended.

even these need analog techniques to help them behave and save power. On a good day, analog engineers are wild men about saving power. Sometimes we are very good at it.

Even a digital computer may need analog circuits, such as low-voltage differential signaling (LVDS), to transfer a lot of data from place to place. All you digital engineers now know that you can't just feed some full-size digital signals at high speed to a different location, like on a backplane, or on flex cabling, at flat-out speed.

You have to engineer (using refined techniques) the signals into small, balanced (push-pull) differential signals. Then, you have to put the signals on carefully laid-out transmission lines. And, you have to use nice little preamps to recover the signals at the required place.

Note that these are analog techniques.

I used to think that LVDS was the dumbest idea in the world. Why would anybody buy that? Then, after a long time, I began to realize that if LVDS were so stupid, nobody would buy it. Yet these LVDS drivers, multiplexers, and receivers were selling well, and the business was even expanding. It was I who was kind of dumb.

People wouldn't buy them if they weren't useful, cost-effective, and valuable, even if I was too stupid and slow to see the value. After all, it was my old colleague Jay Last, one of the original Fairchild Eight, who observed, "The only valid market survey is a signed purchase order." A lot of analog circuits are sold that way. The customer knows what the ICs are useful for, even if the maker does not.

An operational amplifier is called that because it can perform just about any operation according to what feedback components you put around it. The beauty of the op amp is exactly what things the customer can (and does) think to do with an amplifier, or a regulator, that we never thought of or told him how to do (*Fig. 3*).

New applications are invented every day! Often, the customer does that inventing. Sometimes he tells us what he's



## What's All Analog Engineering Stuff, Anyhow?

doing or asks if it's okay. But usually he is too busy to tell us, and sometimes he really doesn't want to tell anybody.

Analog drivers are also needed for backplane drivers and display drivers in computer displays. Getting a lot of info up there needs careful analog planning, not just a lot of wires. There are still a lot of applications that depend on layout to get a circuit to work well. And, many parts of a good layout depend on analog engineering.

Some wireless techniques rely on a lot of digital codes. That's very true. But to pick these codes out of the air, the preamps need analog techniques, with good RF preamps. They need mixers and AVC circuits to avoid overloading. I'm not a very good RF engineer, but I know that the art of RF engineering isn't simple. If a digital engineer can do it, that is all very good, but then we should properly call him an RF engineer.

### What's Next?

---

Are we analog engineers worried about the analog business dying out? I don't think so. Every year, we are confronted with more work and problems than we can do in a year and a half or two years. Most of it is profitable. A lot of it is fun! If I weren't having fun, I would go away and

do something else.

I've never been tempted to do that. The analog business is almost always challenging. Our work often involves challenges where computers or simulation cannot help us. But experimenting often can. And thinking often can.

In the last year, some of my buddies showed me some excellent audio amplifiers with nonlinearity down near or below 1 ppm. I studied around and measured, and I found these amplifiers were actually 10 times better than the engineers thought they were, using advanced analog measurement and analysis techniques. I also cheated by bringing in various resistor and series R-C networks. There are still things you can do with Rs and Cs that are fun ways to solve problems, and they are not obvious!

If you're an analog engineer, don't jump off any bridges because somebody tells you that Moore's law will put you out of business. (In actuality, I have indications and proofs showing that Moore's law is the one in trouble.) Stick together with your analog buddies and keep solving tough problems. I think you will be rewarded. We're going to keep on having a lot of fun— analog circuit fun. ■

*RAP/Robert A. Pease/Engineer*

*to view this article online,  [click here](#)*

[Back to Table of Contents](#)



# What's All This Technical Reading Stuff, Anyhow

*Originally published March 1994*

**R**ecently a young engineer, Barrett L. of Poughkeepsie N.Y., wrote me a letter. He not only ordered one of my books, but he asked my advice and opinion: "I'm a recent E.E. graduate, and if you could please supply me with a list of suggested reading (i.e. books, periodicals, columns) it would be greatly appreciated." Well, I *had* to reply:

"Dear Mr. L.--Darn it, you are the second person this week to ask me this question, and while I was stupid enough not to get the message the first time, I won't miss the message twice. Fortunately, there are several good books I can recommend.

You have not gone wrong in ordering my book

## What's All This Technical Reading Stuff, Anyhow?

on *Troubleshooting Analog Circuits*<sup>1</sup>. I try to keep things light and breezy, with REAL examples. And I also try to minimize the platitudes, as you have noted that nothing gets me TICKED OFF faster than meaningless platitudes. I think real engineers get their education from EXAMPLES, and I try to write accordingly.

A second related book, from the same publishers, is *Analog Circuit Design*<sup>2</sup>, edited by Jim Williams. It consists of about 33 chapters from 23 authors. It, too, is educational in terms of EXAMPLES. Some of the chapters are so-so (in my opinion) and then they get better and better, up to great. The chapters by John Addis and Derek Bowers are great. I wrote two good chapters.

NOW, if you laid hands on this book you might decide that you wanted to buy it, OR you might read a few chapters and then put it back on the shelf. So get your librarian--your town librarian or your company librarian--to order it. If you ain't on good terms with your librarian, you should be. After the librarian buys it, it can be shared by a good number of people.

Nextly, there's Horowitz and Hill's *The Art of Electronics*<sup>3</sup>. Any bookstore will order it for you. It's in its second edition----very popular, fun to read, good insights. Your company librarian would

be wise to buy this one if there are more than six engineers in your company. Maybe you have read this already. It's a good reference book. If there are older engineers who went through school before this book came out, or technicians, they may find this of high value.

At this point, I gotta ask you, Barrett, where are you *coming from*? What good electronics books have you read? Did you take a lot of electronics courses? How many analog, how many digital, how many software? I can assure you, I can give you ZERO advice on software. I have written a couple of successful chunks of BASIC, but my opinions are worthless. I can't give you much advice on digital circuits, and books thereon, but I'll ask my friends.

Next question for you--in which direction do you think you are *going*?? Analog, ADCs, or systems? Low power? High speed? Lotsa processors and a little analog? Just trying to get a broader education? That will make some difference. Or, if you're not sure where you're headed, well, the broad perception from reading a lot will be good for you.

OF COURSE you gotta keep reading *Electronic Design*.<sup>4</sup> It gives you a good clear presentation of some of the newer ideas, circuits, concepts, and trends, with intelligent guys from the

## What's All This Technical Reading Stuff, Anyhow?

industry trying to make good explanations----trying to play teacher. One item of advice: Read and mark the hell out of any stories that are interesting. Xerox or cross-index the stories that are of good interest, but don't throw the magazines away for at least five years. You can go back in several years and see what's interesting, what's trivial, and what's pass,. Note, a five-year stack of ED just fills two "Xerox-paper boxes," about 2.5 cubic feet....

Read hobby magazines ----*Popular Electronics*<sup>5</sup> or similar publications. Some of the stuff is trivial, but that's OK----sometimes it's good to read stuff where you're smarter than the authors, and you can see if they're doing something stupid.

James Roberge of MIT wrote an excellent book about op amps in general, and about the LM301A in particular.<sup>6</sup> The first half explains how the '301 chip was engineered; the second half goes into how you can apply a '301. I asked James and he said it's still in print. It's a very good read.

The advanced, expert book on op amps is by Jiri Dostal----*Operational*

*Amplifiers (second edition)*<sup>7</sup>. I'm selling these for \$53. This used to sell for \$113 from Elsevier Scientific, and was worth it. Now at \$53, it's a bargain. Serious, thoughtful. NOT your FIRST primer on op amps, but any serious user of op amps should read this about once a year. You'll learn something new every time. However, that statement is true for almost every one of these books: All of these books are well worth rereading every year or two.

Now, darn near your first primer on op amps is Tom Frederiksen's *Intuitive IC Op Amps*.<sup>8</sup> Heck of a fine book. Where is it sold? Tom still has some to sell. If you want to use op amps, you want to do it intuitively. No

fancy formulae, no matrices, no Taguchi optimization. Just common-sense engineering with good intuitive insights. Tom's an excellent teacher for that.

The NEXT primer on op amps is NSC's linear databook on op amps.<sup>9</sup> The history of op amps was written there.

NOW, Analog Devices' op-amp databook might be almost as good as NSC's, but they usually don't include device

**In which direction  
do you think you are  
going?? Analog, ADCs,  
or systems? Low  
power? High speed?  
Lotsa processors and  
a little analog? Just  
trying to get a broader  
education?**

## What's All This Technical Reading Stuff, Anyhow?

schematics. If you want an AD databook, call them up.<sup>10</sup> You can request and study databooks from anybody in the whole electronics industry, but I find the ones that do include schematic diagrams (of the devices themselves) are the most useful and educational.

NEXT, NSC's *Linear Applications Handbook*.<sup>11</sup> Some of the better early linear IC applications breakthroughs have gone into there. It's indexed pretty well, so you can find what you want.

NSC's databook on regulators and power ICs<sup>12</sup> is quite good---a useful basic reference book. Also falling into that category is the *Data Acquisition Databook*<sup>13</sup>, which covers DACs, ADCs, voltage references, and temperature sensors. Another is the *Linear Applications-Specific ICs Databook*,<sup>14</sup> which includes several strange but useful ICs.

The list price for these NSC handbooks is usually about \$10 or \$15 each. But our marketing guys agreed that we ought to make a special offer to readers of *Electronic Design*---serious engineers. If you want any or all five of those linear databooks, just call and ask for the set.<sup>15</sup> Not a bad deal.

If you ever have to do "optimization" or quality problem-solving, buy the books that cite "Taguchi" in them the fewest number of times. I just got

around to reading Keki Bhote's book<sup>16</sup>, full of excellent common sense. I started out skeptical, but eventually decided I really liked his style and common-sense approaches. Hans Bajaria has a good book.<sup>17</sup> So does Forrest Breyfogle.<sup>18</sup> And Diamond's book<sup>19</sup> is good, too. Just keep away from books by Genichi Taguchi, and all his friends who tell you how great it is to use orthogonal matrices to solve any problem and you don't have to think... (if you know what I mean, and I think you do).

Recently, I was introduced to a new book by Dennis Feucht, *Handbook of Analog Circuit Design*.<sup>20</sup> It really covers lots of the things a designer needs to know about analog circuits. I'm favorably impressed, and I recommend it. It has good chapters on wideband amplification, precision amplification, feedback circuits, frequency compensation, signal-processing circuits, etc. There's some overlap with Hill and Horowitz, but that's good, not bad.

Another good new book is *High-speed Digital Design*, by Howard Johnson, subtitled *A Handbook of Black Magic*.<sup>21</sup> I thought it was pretty good, so I loaned this to one of our best digital/mixed-signal designers. I was a little surprised when he returned it right away. He said that was because he had

## What's All This Technical Reading Stuff, Anyhow?

gone out and bought several copies for the guys in his group. It treats the gray area between signals that are digital, and the analog aspects that are so important when you want your digital buses to behave at higher and higher speeds----not a trivial task. This book is there to help, with serious advice and good philosophy. You ain't gonna get much of that anywhere else these days.

One of my old fans, Reg Neale, recommended a book on *ESD, ESD from A to Z*, by John Kolyer.<sup>22</sup> I discovered the book in our library, read through it, and found a number of thoughtful observations. Just as my book is the "best" book on Troubleshooting, so this book may well be the "best" on ESD, and *partly* for the same reason----it's the~ only one.

When I wrote about Ground Noise in June, I recommended the excellent book by John Barnes, *Electronic System Design*,<sup>23</sup> and I still do. Also, a friend recommended *Noise Reduction Techniques in Electronic Systems*, by Henry Ott.<sup>24</sup> Its second edition just came out, and it, too, covers many topics that aren't taught in schools. If you work with RFI and EMI in real systems, you'll probably profit by buying and reading *both* of these books.

Recently, Barrett, a reader asked me what book can I recommend to teach

about designing printed-circuit boards? I asked several friends----no ideas, no recommendation. Maybe some of our readers can recommend a book? There ought to be something beyond the literature of the pc-board-design software people...

Also, you and other readers who recall the question and debate of the value of a Bachelor's Degree versus an Associate's Degree in Electronics Technology may be interested in a new book by Joel Butler, *High-Technology Degree Alternatives*.<sup>25</sup> He observes that you don't have to go to school at night for a dozen years, nor drop out of work and pay tuition for four years. He has several suggestions on how you can get credit for school courses and work you have already accomplished. He recommends a list of a few dozen schools where you can apply by mail. This sounds kind of unlikely, except Mr. Butler points out that these schools actually are ACCREDITED, which isn't a trivial statement.

One last "book," actually some stories on floppies, was sent to me by Geoff Harries, a reader located in Munich, Germany. They are Science Fiction, sort of high-tech and time-travel, and good historical stuff, too. He's still trying to get a publisher. Meanwhile he gave me permission to sell you his book, ChronDisp

## What's All This Technical Reading Stuff, Anyhow?

I (about 700 kbytes) on a high-density IBM-type floppy for about the same price as a paperback book. I will repatriate all proceeds to Geoff. I enjoyed the book, and I recommend it to you, too. It's kind of fun to sit there in the evening, hitting "Page Down," again and again, reading Geoff's stories.<sup>26</sup>

Well, there is my list. This may not be a DEFINITIVE list, but it's a good start. Ask your buddies. Borrow some of their hobby magazines. Also, you will probably want to read one or two general-purpose science magazines. I used to read *Scientific American*,<sup>27</sup> but a year ago I gave up on them and changed over to *Discover*.<sup>28</sup> Maybe Sci Am is coming back, but I still think *Discover* is excellent. Try *Machine Design*.<sup>29</sup> You can spend a lot of time reading this, but it's fun and educational. You'll see several kinds of good engineering.

Ah----yes, let's not overlook the obvious. You should also read your own company's catalog or data sheets. Look at what it says to your customers, and look at the circuits "behind the front panel." I don't know what your company

does or makes, but let's assume there are PRODUCTS somewhere. When I joined Philbrick in '61, I studied the heck out of all its schematics and data sheets, op amps, and analog computing products. Then I would say to myself, "Why did they do *that?*" I surely couldn't understand everything, but by asking all questions that came to mind, I got a heck of an education.

Similarly, when I came to NSC in 1976, I studied all of the op amps, data sheets, schematics, AND layouts. I'm sure you will agree that in an IC, the layout can be even more important than the schematic. In my first year at NSC, I spotted a philosophical error in the layout of a popular amplifier. The changes I suggested caused the yield to go up on the LF356, the LF256, AND the LF156, by a factor of 2, EACH. That yield improvement paid for my first couple years' salary, even if I had done nothing else.... So, read your own company's literature, and the serious art (schematics, layout, software, or whatever) that's behind the scenes.

NOW you can plainly see that I have

**Then I would say to myself, "Why did they do that?" I surely couldn't understand everything, but by asking all questions that came to mind, I got a heck of an education.**

## What's All This Technical Reading Stuff, Anyhow?

written a whole column around your request, for pity's sake! I hope I have answered the question for you and for many other guys who are just out of school and trying to get going----up the LEARNING CURVE. So, read books and think of good questions. When you have answered as many as you can, and you have asked your colleagues, and there are still some you cannot answer, write down some notes and ask one of your Senior Engineers. He'll probably be flattered to get thoughtful questions from a serious student. If you ask reasonably, he/she may provide some (priceless) mentoring. Have fun, Barrett!!" ■

*RAP/Robert A. Pease/Engineer*

### REFERENCES

1. Troubleshooting Analog Circuits, 3rd Printing, Robert A. Pease, 1992, 208 pages. Butterworth-Heinemann. Order from Robert Pease, 682 Miramar Ave., San Francisco, CA 94112. NOW in PAPERBACK----NEW LOW PRICE----\$25.95 including tax & shipping.
2. Analog Circuit Design: Art, Science, and Personalities, edited by Jim Williams, 1992, 222 pages. Order from Robert Pease, (see address in reference 1) \$47.95 includes tax & shipping; or order it from the publishers, Butterworth-Heinemann, Stoneham, MA; (800) 366-2665 or (617) 438-8464.
3. The Art of Electronics (2nd Edition), Paul Horowitz and Winfield Hill, 1989, 800 pages. About \$60. Cambridge University Press, NY; (914) 937-9600 or (800) 872-7423. In NY, (800) 227-0247.
4. Electronic Design, Penton Publishing. To apply for a free subscription, write to Electronic Design, Reader Service Dept., 1100 Superior Ave., Cleveland, Ohio 44197-8132.
5. Popular Electronics, about \$19 per year. Call (800) 827-0383 or (516) 293-3000.
6. Operational Amplifiers: Theory and Practice, James Roberge, 1975, 678 pages. About \$71. Wiley/Krieger. Call (407) 724-9542.
7. Operational Amplifiers (Second Edition), Jiri Dostal, 1993, 555 pages. Butterworth-Heinemann, Stoneham, MA. Available from Robert Pease for \$53, including tax & shipping. (see address in reference 1)
8. Intuitive IC Op Amps, Thomas M. Frederiksen, McGraw-Hill, 1988, 352 pages. Order from Thomas Frederiksen, 24705 Spanish Oaks, Los Gatos, CA 95030; \$25.00 including tax & shipping.
9. Operational Amplifiers Databook, National Semiconductor Corp., 1993. Publication No. 400061.
10. Analog Devices Inc., Literature Dept. (617) 461-3392.
11. Linear Applications Handbook, National Semiconductor Corp., 1994. Publication No. 400043.



## What's All This Technical Reading Stuff, Anyhow?

12. Power ICs Databook, NSC 1993. Publication No. 400062.
  13. Data Acquisition Databook, NSC, 1993. Publication No. 400033.
  14. Linear Application-Specific ICs Databook, NSC 1993. Publication No. 400060.
  15. Set of 5 NSC linear databooks----items 9, 11, 12, 13, and 14 above----call the NSC Customer Response Center, (800) 272-9959 or (817) 468-6811.
  16. World Class Quality: Using Design of Experiments to Make It Happen, Keki R. Bhote, AMACOM, 135 W. 50th St. NY, NY 10020; (518) 891-5510 About \$25.
  17. Statistical Problem Solving----A Team Process for Identifying and Resolving Problems, Hans Bajaria & Richard Copp, 1991, 300 pages. About \$45. Multiface Publishing Co., Garden City, MI; (313) 421-6330.
  18. Statistical Methods for Testing, Development, and Manufacturing, Forrest Breyfogle, John Wiley & Sons, 1992; (908) 469-4400. About \$65.
  19. Practical Experiment Designs for Engineers and Scientists, William Diamond, 1981, 347 pages. Van Nostrand Reinhold, NY. About \$55. Call (800) 842-3636 or (606) 525-6600.
  20. Handbook of Analog Circuit Design, Dennis L. Feucht, 1990, 685 pages. About \$65. Academic Press/Harcourt Brace Jovanovich, San Diego, CA; (800) 782-4479 or (407) 345-2500.
  21. High-speed Digital Design (A Handbook of Black Magic), Howard Johnson and Martin Graham, 1993. About \$47. PTR Prentice-Hall, Englewood Cliffs, NJ; (206) 556-0800.
  22. ESD from A to Z, John Kolyer and Donald E. Watson, 1990, Van Nostrand Reinhold, NY; (800) 842-3636 or (606) 525-6600. About \$47.
  23. Electronic System Design: Interference and Noise-Control Techniques, John R. Barnes, 1987, 144 pages. About \$48. Prentice-Hall, NY; (800) 947-7700 (out of print).
  24. Noise Reduction Techniques in Electronic Systems, (2nd edition), Henry Ott, 1988, 426 pages. About \$65. John Wiley & Sons, NY; (908) 469-4400.
  25. High-Technology Degree Alternatives, Joel Butler, 1994, Professional Publications, 1250 Fifth Ave., Belmont, CA 94002; (415) 593-9119. About \$22.
  26. ChronDisp I: The Gun From The Past, Geoff Harries, 1993, Munich, Germany. Can be ordered on a high-density IBM-compatible floppy disk for \$4.00 (including tax & shipping) from Robert A. Pease, 682 Miramar Ave., San Francisco, CA 94112.
  27. Scientific American, about \$36/year. Call (800) 333-1199 or (515) 247-7631.
  28. Discover, Family Media, NY. About \$27/year. P.O. Box 420105, Palm Coast FL 32142; (800) 829-9132.
  29. Machine Design, a Penton Publication. Write on letterhead to 1100 Superior Ave., Cleveland Ohio, 44114-2543.
- to view this article online,  [click here](#)*

[Back to Table of Contents](#)



# (Part 1) What's All This Transimpedance Amplifier Stuff, Anyhow

*Originally published January 2001*

One of the first things you learn about operational amplifiers (op amps) is that the op amp's gain is very high. Now, let's connect a feedback resistor across it, from the output to the -input. When you put some input current into the -input (also known as the summing point), the gain is so high that all of the current must go through the feedback resistor. So, the output will be  $V_{OUT} = -(I_{IN} \times R_F)$ . That's neat (*Fig. 1*). While we used to call this a "current-to-voltage converter," which it is indeed, it's also sometimes referred to as a "transimpedance amplifier," where the "gain" or "transimpedance" is equal to  $R_F$ .

## (Part 1) What's All This Transimpedance Amplifier Stuff, Anyhow?

There's a whole class of applications in which this configuration is quite useful and important. An important case is when you need an op amp to amplify the signal from a sensor, such as a photodiode. Photodiodes put out current at high impedance (high at dc), but often they have a lot of capacitance. If you just let the photodiode dump its current out into a resistor, there are two problems (Fig. 2). If the sense resistor is large, then the gain can be fairly large, but the response will be slow and the time-constant will

be large:  $t = R_L \times C_S$ . But if you choose a small sense resistor to get a small  $t$ , the gain will be low. The signal-to-noise ratio (SNR) may also be unacceptable. How can you avoid poor gain and/or poor response? Kay garney? (That's Nepali for "What to do?")

To avoid this terrible compromise, it's a good idea to feed the photodi-

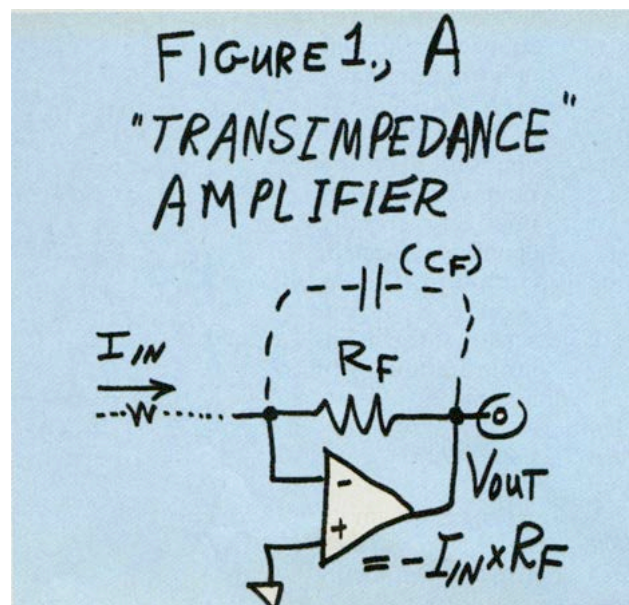

ode's output current directly into the summing point of a transimpedance amplifier (Fig. 3). Here, the response time is not  $R_F \times C_S$ , but considerably faster. Plus, the gain can be considerably larger, because now you can use a larger  $R_F$ . This helps improve the signal-to-noise ratio too!

When you connect up the diode like this, the first thing you realize is that the darned thing is oscillating! Why? Well, it's well known that the input capacitance of an op amp (and its circuitry) can cause instability when the op amp

is used with a feedback resistor. You usually need to add a feedback capacitor across  $R_F$  to make it stable. In the old days, it was stated that:

$$C_F \times R_F = C_{IN} \times R_{IN}$$

So if you have a unity-gain inverter with  $R_{IN} = R_F = 1 \text{ MO}$ , and the input capacitance of the op amp is 10 pF, then you're

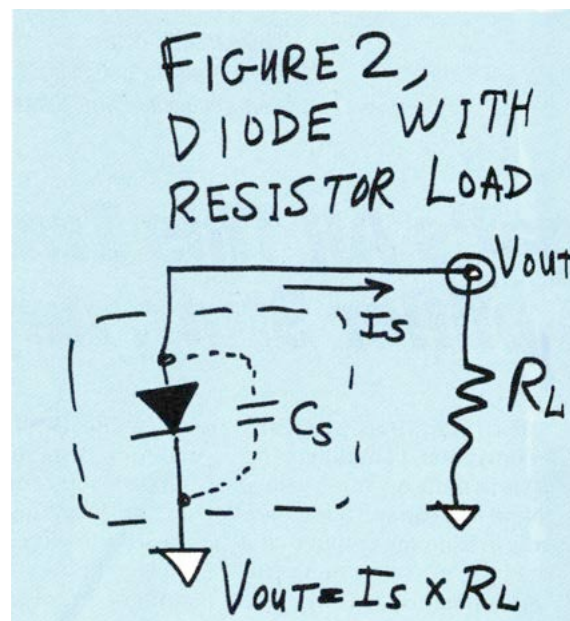

## (Part 1) What's All This Transimpedance Amplifier Stuff, Anyhow?

supposed to install a feedback capacitor of 10 pF. That's what people said for years. The LF156 data sheet stated this, and it still does. But that's not exactly true. A complete explanation is a bit beyond the scope of this column, but in practice you can usually get away with a much smaller feedback capacitor. In many cases, you can get a response that's improved by a factor of five or 10, and still not get excessive (more than 5% or 10%) overshoot. In practice, you have to tweak and optimize the feedback capacitance as you observe the response.

The formula for the optimized amount of  $C_F$  is, if:

$$\left( \frac{R_F}{R_{IN}} + 1 \right) \geq 2\sqrt{GBW \times R_F \times C_S}$$

then:

$$C_F = \frac{C_S}{2 \left( \frac{R_F}{R_{IN}} + 1 \right)}$$

but if:

$$\left( \frac{R_F}{R_{IN}} + 1 \right) < 2\sqrt{GBW \times R_F \times C_S}$$

the feedback capacitor  $C_F$  should be:

$$C_F = \sqrt{\frac{C_S}{GBW \times R_F}}$$

Now, whenever you have an op amp with a large  $C_S$ , a large  $R_F$ , and a small  $C_F$ , the noise gain will rise at moderate frequencies. The definition of noise gain is the reciprocal of the attenuation from the output back to the -input. In other words, if the attenuation is  $Z_{IN}/(Z_{IN} + Z_F)$ , then the noise gain is  $1 + Z_F/Z_{IN}$ .

At moderate frequencies, the  $Z_F$  is determined by  $R_F$ , and  $Z_{IN}$  is established by  $C_S$ . So, the noise gain will rise until the frequency where the impedance of  $C_F$  becomes equal to  $R_F$ . Then the noise gain flattens out, typically at a large number, such as 20, 40, or 80. We do this because if the noise gain kept rising at 6 dB/octave while the op amp's gain is rolling off at 6 dB/octave, the loop is going to be unstable, and it will oscillate. The reason that we choose a small value of  $C_F$  is to make the noise gain flatten out, make the loop stable, and stop the oscillation and ringing (*Fig. 4*).

If you make  $C_F = C_{IN}$ , you can get the noise-gain curve to stay flat as in line A-E. It will be very stable but have a very slow response. If you add no feedback capacitor, the noise gain will tend to rise as per line A-B-C. This will cause instability. Selecting a suitable small value for  $C_F$  can get the smooth results shown by line A-B-D. Yeah, it's as easy as ABD to get fast, stable response by

## (Part 1) What's All This Transimpedance Amplifier Stuff, Anyway?

picking a small  $C_F$ . So, we have made the feedback capacitance big enough to stop the oscillation and minimize the overshoot. Now what?

There's a pretty good book by Jerald Graeme (ex-Burr-Brown) on the topic of the transconductance amplifier: *Photodiode Amplifiers—Op Amp Solutions*. Jerry and I have definitely come to the same basic conclusion. When you want to optimize a transimpedance amplifier, everything interacts. Therefore, every time you compute the response and the noise, and change any factor, the computations may change considerably. There's no simple or obvious way to compute or optimize the performance. The performance, in terms of response or bandwidth, in terms of peaking or overshoot, and in terms of noise or SNR, is an extremely complicated, nonlinear, and highly interacting function of:

- the feedback resistor
- the source capacitance
- the feedback capacitance
- the desired bandwidth
- the desired gain factor (which does predict the full-scale output voltage)

- the voltage noise of the op amp
- the current noise of the op amp
- the input capacitances of the op amp
- and the gain-bandwidth product of the op amp.

Jerry and I certainly agree on that. Jerry's book is well written, and for just \$55, it's pretty much a bargain. I recommend it: ISBN = 0-07-024237-X.

But I also have worked on this general problem many times over the years and have several suggestions that go beyond Jerry's book. More on this later.

There are several basic rules of thumb that Jerry and I agree upon:

(A) You want to avoid an op amp with high voltage noise (nV/vHz).

(B) You want to avoid an op amp with high current noise (pA/vHz). (Most bipolar op amps have much higher current noise than FETs.) It's a rare case when an op amp with bipolar input transistors is better, except when  $R_S$  is very low or resistive (or in cases where the input is capacitive but the bandwidth is narrow).

(C) You usually want to avoid an op amp with large input capacitance. Unfortunately, most data

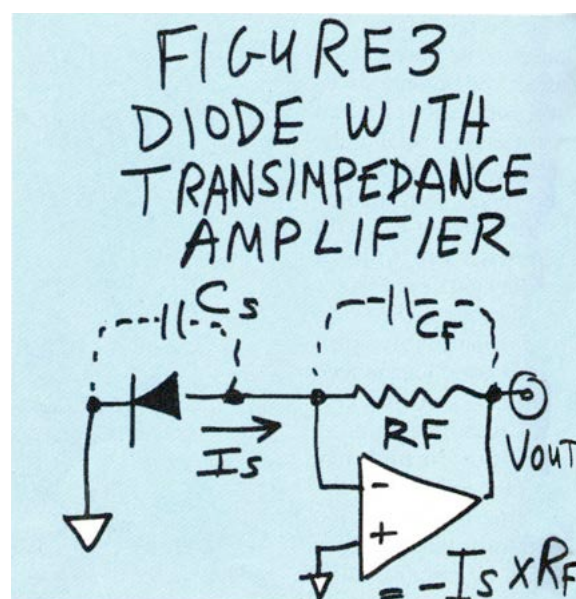

## (Part 1) What's All This Transimpedance Amplifier Stuff, Anyway?

sheets don't properly specify the op amp's input capacitances, neither differential-mode nor common-mode. But it's fair to assume that most "low-noise" op amps have a larger input capacitance than ordinary op amps. You may want to ask the manufacturer, or you might just decide to measure it yourself.

(D) Much of the noise of such a transimpedance amplifier is proportional to  $\sqrt{\text{BW}} \times C_{\text{SOURCE}} \times V_{\text{N}}$  of the op amp. So if you want to get low noise, you must optimize very carefully. Specifically, begin by computing the impedance  $Z_{\text{S}}$  of your sensor at the maximum frequency of interest:

$$Z_{\text{S}} = 1/2\pi f C_{\text{S}}$$

For a good amplifier, the voltage noise and the current noise times  $Z_{\text{S}}$  should both be as small as you can get. If one of these noises is much larger than the other, then you're probably far off

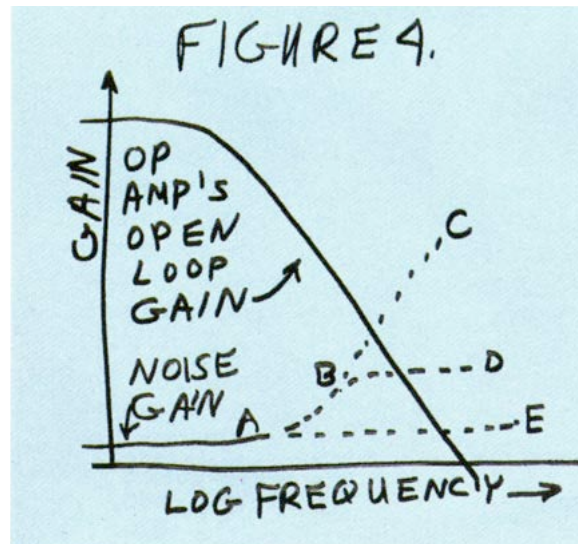

optimum.

(E) If you have any choice of what sensor you employ, try to find a lower-capacitance sensor. Furthermore, make a low-capacitance layout between the sensor and the op amp.

If you want to get fast response, low noise, or wide bandwidth, Jerry's

book offers some pretty good advice. More on that later.

But Jerry didn't include a list of good op amps that have low voltage noise, and/or low current noise, and/or low input capacitance.

Also, Jerry neglected to mention that you can design your own op amp with better, lower voltage noise and better bandwidth. I mean, op amps that you can buy off the shelf cover a wide array of cases where they are optimized for low  $V_{\text{NOISE}}$  and low  $I_{\text{NOISE}}$ , wide bandwidth, low power drain, and so on. But you can "roll your own" surprisingly easily and accomplish

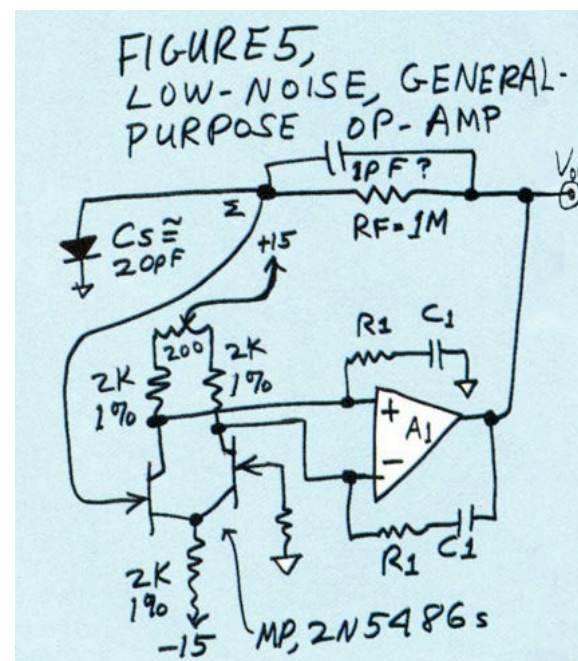

## (Part 1) What's All This Transimpedance Amplifier Stuff, Anyway?

even better performance for a specified application! I'm not proposing that you design a complete op amp, but it's simple to just add a new low-noise front end ahead of a suitable op amp.

The basic idea is to add a couple of good low-noise FETs in front of an existing op amp. Most op amps don't operate the front-end transistors as rich as the output. Yet in a case like this, there's no reason at all not to run more current through the front end than in the rest of the op amp. My first pick is the 2N5486, which has less than 1 pF of  $C_{RSS}$ , but has a lot of  $g_{ms}$  (4 millimhos) and low voltage noise (at  $I_S = 3$  mA). So for my first design, I'll just put a matched pair\* of 2N5486s in front of a decent wideband op amp, such as the LM6171 (Fig. 5). What's the voltage noise of this amplifier? We may be able to get an average of 3 nV/vHz, out to 10 kHz.

When you're designing an op amp, remember this: adding gain is one of the cheapest things you can add. You only need to be careful about

how to give that gain away—to roll it off.

In this case, it's easy. The R1-C1 network in *Figure 5* just rolls off the gain for a fairly smooth frequency response. To achieve 2 MHz of bandwidth and a fairly good, smooth 6-dB/octave rolloff, I suggest  $R1 = 75 \Omega$ , and  $C1 = 100$  pF as a good place to start your design.

But now, look at the refinements in *Figure 6*. We can roll off the amplifier's gain simply in two swoops. The low-frequency gain is rolled off by  $R_X$  and  $C_X$ . Then after the gain rolls off flatly, we roll it off some more by  $R_Y$  and  $C_Y$ .

When we are finished, it should look something like curve X in *Figure 7*. This isn't exactly rocket science. We just want to make it a practical design. But this is a whole system design. You can't very well design and optimize the op amp alone. It's the op amp, the feedback system, the noise filters, and the post-amplifiers that have to be considered and optimized all together. My first-hack proposals for these damping/stabilization

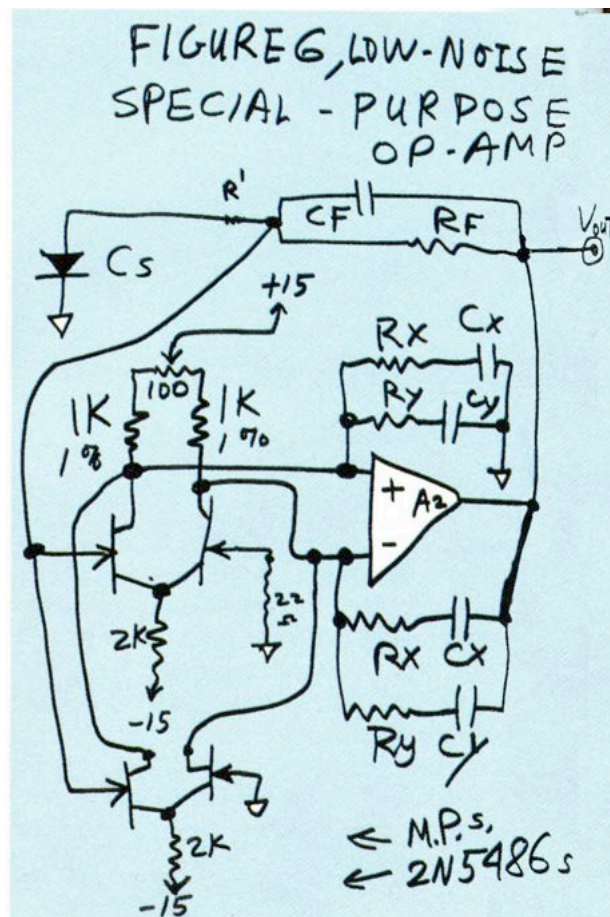

## (Part 1) What's All This Transimpedance Amplifier Stuff, Anyhow?

components are:

$$R_X = 5.1 \text{ k}\Omega, C_X = 50 \text{ pF}$$

$$R_Y = 330 \Omega, C_Y = 7.5 \text{ pF}$$

The whole point behind making your own op amp is that you do not have to just build an op amp with a smooth 6-dB/octave roll-off, all the way out to a few megahertz. You can roll off the gain at a 6 dB/octave out to some intermediate frequency, and then flatten out the gain. Then, at a higher frequency, let it roll off some more in some vaguely controlled way. This would make a lousy general-purpose op amp, but it might be ideal for a case where the noise gain is rising, such as in a transimpedance amplifier. (Look at the old LM709. When you choose the correct damping networks, it can provide a gain of 1000 out to some high frequency like 1 MHz.)

Also note that I added a second pair of 2N5486s to improve the voltage noise. Yes, this will approximately *double* the input capacitance. But if your  $C_S$  is already large, this may easily improve the signal-to-noise ratio. If it's good to

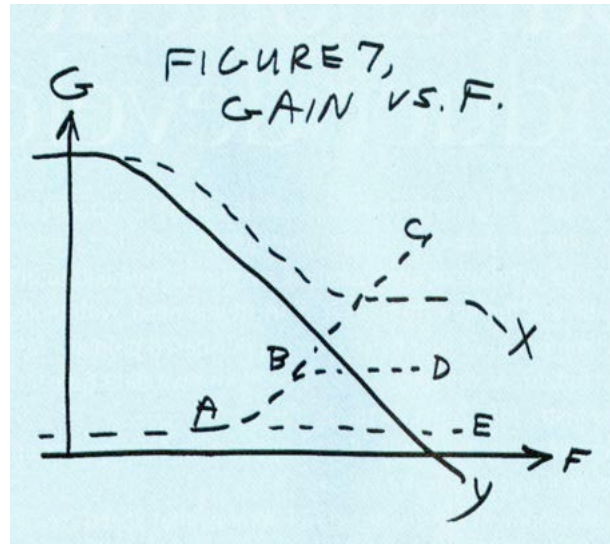

have two, will three be better? I'll let you figure that out! But, yes, four or five may provide definite improvements... or that might not be the case.

I won't recommend that you design your own op amp if you can buy one that does the job. But if the best one you can buy isn't good

enough, then there's some hope here. Designing your own composite op amp is not that hard, and not that expensive, even if you are going to build one or 10 or 1000. The post-amplifier can be inexpensive. Of course, all of the basic designs will be somewhat different if you are running on  $\pm 5\text{-V}$  supplies, or  $\pm 15\text{-V}$  supplies.

Either way, it's not that difficult, but the design compromises are slightly different. Here, I just showed a couple of  $\pm 15\text{-V}$  applications. (The  $\pm 5\text{-V}$  designs differ mostly by using a low-voltage, rail-to-rail-output op amp.)

In future columns on this topic, I will comment on other aspects of design and optimization for transimpedance amplifiers.

Meanwhile, try to avoid Tee networks in the feedback network. They often



## (Part 1) What's All This Transimpedance Amplifier Stuff, Anyway?

cause poor signal-to-noise ratios. Next time, I'll explain that completely. Yes, a Tee network might help you avoid buying 1000-MO resistors, but that's only okay when you have proven that the noise is okay. ■

*RAP / Robert A. Pease / Engineer*

\*For this case, grade a good number of 2N5486s into 20-mV bins of  $V_S$ , with  $V_{GD} = 7$  V, and  $I_S = 3.8$  mA. Take units out of the same bin for good matched pairs.

P.S. If you design in an op amp, try to avoid relying on nonguaranteed charac-

teristics, such as noise, which is rarely guaranteed.

P.P.S. I neglected to mention that any resistor may have a built-in capacitance of 0.3 to 0.8 pF. If you add that to any imperfect layout, the capacitance could be so big that you wish it were smaller. Good layout and good engineering can easily cut the C to less than 0.2 pf. For example, make the feedback resistance out of three or four resistors in series, and install a shield land between the ends of the resistor.

*to view this article online,  [click here](#)*

[Back to Table of Contents](#)



# What's All This Frequency- To-Voltage Converter Stuff, Anyhow

*Originally published July 1993*

Once upon a time—my gosh, it was 30 years ago—a guy asked me if I could show him how to make a Frequency-to-Voltage converter (FVC). Well, at that time, at George A. Philbrick Researches, we knew a lot about analog computers and we figured we could convert almost any signal to any other form or mode. So I designed a charge-dispenser made of a voltage limiter, a capacitor, and diodes. I built it up, and it worked pretty well.

And in 1964 we put this into the old Philbrick Applications Manual.1 (*Fig. 1*).

The first amplifier has a limited output voltage. The p-p voltage across the capacitor is pretty well

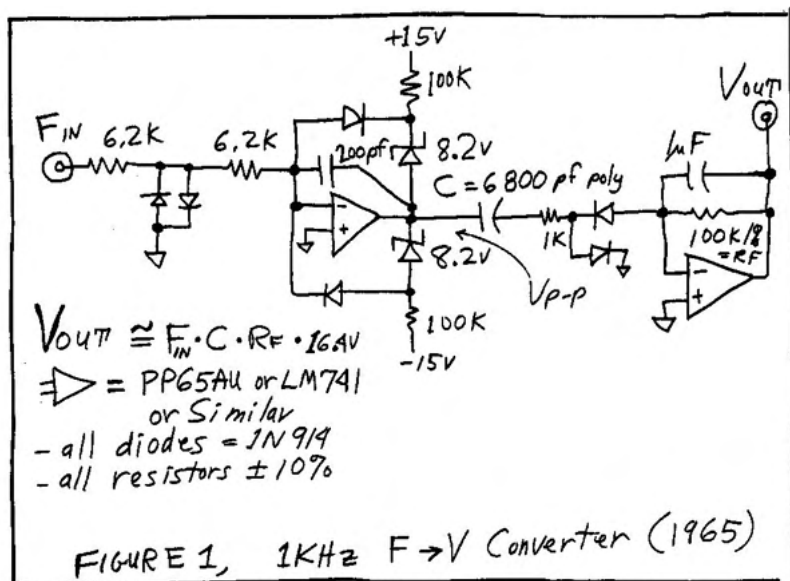

established:

$$V_{p-p} = 2V_z + 2V_d - 2V_d$$

So, the charge ( $Q = C \times V_{p-p}$ ) flows through the feedback resistor of the second amplifier. The output voltage will be, on the average:

$$V_{out} = R_f \times C \times V_{p-p} \times f$$

A few years later, we got into the Voltage-to-Frequency Converter (VFC) business. At the same time, I came up with an improved circuit for an FVC (Fig. 2). The input comparator is set up to accommodate TTL signals, but if you put a resistor from the + input to -15 V, you can accommodate symmetrical signals; a resistor from the + input to ground will cut down the hysteresis and let you handle small signals.

But the real improvement in this FVC is the bleeder resistor, the 3.3 M $\Omega$  added to the right end of the capacitor. If you want a charge dispenser to dispense a constant amount of charge, no matter what the rep rate of the pulses, you can't let the voltage at the right end of the capacitor just sit there unattended. That's because it will be charged (through the nonlinear impedance of the diodes) to a different voltage, depending on how long you wait. The 3.3-M $\Omega$  resistor helps pull charge off that node, so the p-p voltage is always constant at high or low speeds.

That is what's required for good linearity—for minimum deviation from the straight line of:

$$V_{out} = k \times F_{in} + (\text{error})$$

Also, note the symmetrical Zener clamp.<sup>2</sup>

Another cute feature was the adaptive filter at the summing point of the second amplifier. The conductance of the diode is linearly proportional to the current through it, so the 1- $\mu$ F capacitor gives an adaptive time constant and helps filter the signal more at low frequencies, less at high frequencies. That's the classical problem with most F-to-V converters: If you want to get low ripple, you get slow response due to the heavy filtering. If you want fast

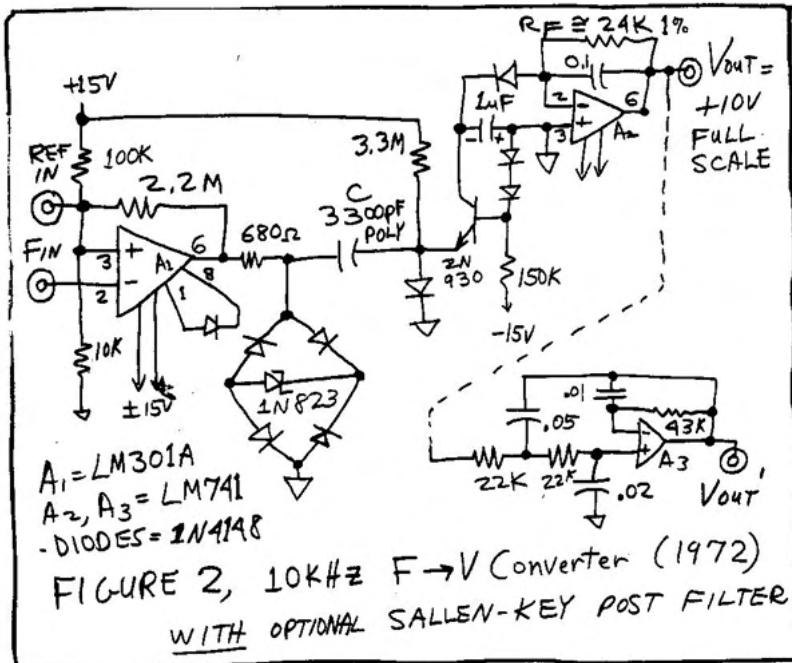

response, it's hard to get low ripple.

After I left Philbrick, I joined National and designed the LM131 voltage-to-frequency converter<sup>3</sup>, using completely different ideas than any of the Philbrick circuits. It used  $Q = I \times T$ , rather than the  $Q = C \times V$  employed by all of the Philbrick ones. It didn't need  $\pm 15$  V; it could run on +15 or +30 or +12 or +5 V—much easier to apply. BUT, it still had the same constraint when you used it as an F-to-V converter: If you want low ripple, it's hard to get fast response.

In 1978, I wrote an application note on how to improve the response time of an FVC—in the Linear Apps Handbook.<sup>4</sup> I showed how to cascade two or more fast Sallen-Key filters to give reasonably quick response, yet filter out the ripple at 24 dB per octave. For example, if you

have a frequency in the range 5 to 10 kHz and the frequency suddenly changes, you can get the output voltage to settle to the new level (within 1%) in about 40 ms—that's about 200 cycles—yet the ripple will be less than 5 mV p-p. That's about a 10:1 improvement over a single R-C filter. Good, but not good enough for some applications.

In 1979, I wrote another App Note<sup>5</sup> showing how to use a phase-locked loop to make a quicker F-to-V converter, about 2 ms. That's about 10 cycles of the new frequency—a further 20:1 improvement.

Not bad—but still not fast enough for everybody. For example, in a control loop, you may need a voltage that represents the frequency, and any delay or lag in the information may cause loop instability. So a fast response can be very important.

Recently, a guy asked me how to make a 60-Hz FVC with quick response and negligible lag or delay. I told him that the standard procedure is to use a fast clock and a digital counter. But the number of counts collected during one period is linearly proportional to the *period* of the signal, and you might have to do some digital computations to convert that to a signal representing the *frequency*. Then I realized that a “multiplying” DAC can be

## What's All This Frequency-To-Voltage Converter Stuff, Anyhow?

used to divide in a reciprocal mode.

I built it up and it worked. This Frequency-to-Voltage converter settles in *one cycle* of the frequency. Besides that, it uses only a small number of parts (Fig. 3).

The digital logic generates a couple of pulses at the time of each rising edge of the incoming frequency (you could use some kind of dual one-shot multivibrator, but I didn't have any of those around). The first pulse loads the data from the CD4040 into the DAC (the pulse also disables the path from the clock to the counter to avoid any confusion from rippling in the counter). Then the second pulse resets the counter.

The MDAC has storage registers built in, so the data from the counter is fed right in to the DAC when the WRITE-2-bar pulse is applied. The MDAC isn't connected in the normal way, with the variable resistance in the input path. The fixed resistor is in the *input*, and the impedance controlled by the Digital code is connected as the feedback resistor. This permits the *multiplying* DAC to act as a divider, so the reciprocal function is done neatly—not in the digital realm, and not in the analog world, but on the cusp between them. (More on this in a few months). The LM607BN was chosen for the op amp because you need low offset. It's cheap,  $V_{os}$  is only 25  $\mu$ V typical

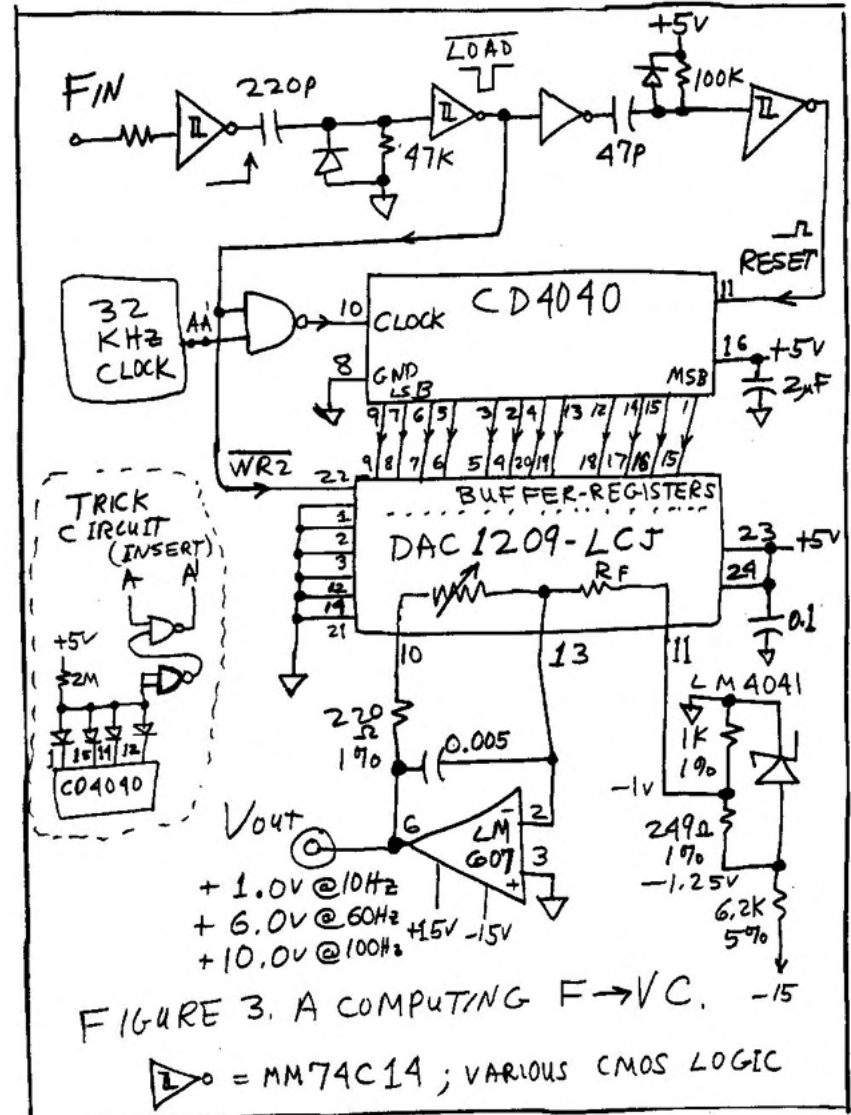

(60  $\mu$ V max.), and you don't need a trimmer pot.

The guy who asked me for this function was quite pleased, as he said there are several suppliers who are happy to sell you this function for a couple hundred dollars.

But it's really not that big a deal. You can do the whole thing yourself. All it takes is just a few dollars worth of parts

## What's All This Frequency-To-Voltage Converter Stuff, Anyhow?

and a little labor.

The main limitation of this scheme is getting a decent resolution on the output voltage if you must cover a wide range of frequencies. For example, if you have to cover a 10:1 range, let's say from 20 to 200 Hz, then you can only use a clock frequency of 20 kHz with a 10-bit counter (or the clock counter would overflow, giving unacceptable false answers).<sup>6</sup> Then at 60 Hz, the number of counts would be just 333. The resolution would be only one part out of 333, or one-third percent.

So, if 200 Hz is scaled for 10 V, 60 Hz for 3 V, and 20 Hz for 1 V, then the FVC can only resolve the difference between 60.18 Hz and 60.000 Hz—for example, 3.000 V and 3.009 V. The resolution at 200 Hz would be even worse, about 100 mV per step, because there are so few COUNTS there.

If you need to get better resolution, you can get a 4X improvement by using a more expensive 12-bit MDAC and a 80 kHz clock. An 8-bit MDAC, even though the price is right, can't give much better than 1% resolution, even if you use it in a dynamic range of just one octave.

So, there's the limitation to this counting method. But you have to admit it is fast and has low ripple! (Of course, the other limitation is that if you wanted a fast computation for a 60-kHz frequency,

you might need a 20 or 80 MHz clock and counter, not impossible, but not so easy....)

*RAP/Robert A. Pease/Engineer*

p.s. And in an upcoming column, I plan to write about Voltage-to-Frequency converters, too.

### REFERENCES:

1. Teledyne Philbrick, Applications Manual, 1965, 1985; p. 95; (out of print).
2. How do you like that little Zener bridge circuit that's inherently symmetrical in its swing? As near as I can tell, it was first published by NSC in an "Applications Corner" in Electronic Design, p. 69, July 5, 1976. I sort of invented it about 1971—has anybody ever seen it before 1976? I don't think I have ever seen any patent on it—and if there had been one, it would have expired by now....
3. LM131/LM231/LM331 Voltage-to-Frequency Converter data sheet; available on request.
4. National Semiconductor Linear Applications Handbook; Appendix D, available on request.
5. Ibid., Application Note AN210.
6. That's the function of the trick circuit shown in Figure 3—to detect when the counter is nearly full, shutting off the clock. This prevents preposterous outputs when the frequency approaches zero.

*to view this article online,  [click here](#)*

[Back to Table of Contents](#)



# What's All This Capacitor Leakage Stuff, Anyhow

*Originally published March 2007*

**W**e all know that capacitors have a shunt resistance (leakage) and that leakage resistance should be pretty easy to measure, right? Wrong! I've measured a lot of capacitors for short-term soakage (dielectric absorption).

After the short-term soakage stops, it's possible (not easy) to measure the leakage. For example, if you charge a good cap up to 9 V for a few seconds, it will start discharging shortly for several millivolts. If you wait long enough, you may see leakage slow down to a few millivolts per hour. But you will see the long-term soakage. Is that different from the short-time leakage? Maybe

## What's All This Capacitor Leakage Stuff, Anyhow?

not.

Now I will charge up some of my favorite low-leakage capacitors (such as Panasonic polypropylene 1  $\mu\text{F}$ ) up to 9.021 V dc (a random voltage) for an hour. I will read the  $V_{\text{OUT}}$  with my favorite high-input-impedance unity-gain follower (LMC662,  $I_b$  about 0.003 pA) and buffer that into my favorite six-digit digital voltmeter (DVM) (Agilent/HP34401A) and monitor the  $V_{\text{OUT}}$  once a day for several days.

Why did I choose 9 V? Because that's within the common-mode range of the op amp and the DVM at highest resolution. I keep the input ball hook connected to +8.8 V dc between readings. I also keep my left hand grounded to +8.8 V.

### DAY BY DAY

One of my e-mail colleagues had been monitoring some good 0.1- $\mu\text{F}$  polystyrenes, and he was impressed that they got down to a leak rate of better than a year after several months. Well, I could see that my polypropylenes had their leak rate improve even better than that in just a few days. Refer to the list of voltages below:

**Day 0:** 9.0214 V

**Day 1:** 9.01870 V

**Day 2:** 9.01756 V

**Day 6:** 9.0135 V

**Day 7:** 9.0123 V

**Day 8:** 9.01018 V

**Day 9:** 9.00941 V

**Day 11:** 9.00788 V

**Day 12:** 9.00544 V

**Day 13:** 9.00422 V

The first day after soaking for an hour, their leak rate was as good as 2.7 mV per day. Not bad.

If you had a 1 million- $\text{M}\Omega$  resistor across a 1- $\mu\text{F}$  capacitor at the 9-V level, it would draw 9 pA, which would pull down the capacitor 778 mV per day. All the capacitor types I tested were better than this, except some “oil-and-paper” caps that supposedly had special qualities for audio signals.

If you had a 10-meg-meg resistance, that would cause the cap to leak down 78 mV/day. With 100 meg-megs, it would be 7.8 mV per day. Several good capacitors soon began to leak slower than that. After a mere week, some of the best caps were leaking at a rate down near 1 mV/day. Quite good. So, what's the big deal?

The big deal is that a time constant of 31.5 meg seconds is one year! So any capacitor leaking less than 2.5 mV per



## What's All This Capacitor Leakage Stuff, Anyway?

day is leaking at a tau (rate) of 10 years or more. If you had to wait a few months to get this leak rate, well, that's not bad. But achieving this leak rate in less than two weeks is, I would say, quite good. Less than a *day*? Spectacular.

So I'm finding that good polypropylene caps are better than the best (old) polystyrenes, in terms of soakage or di-

electric absorption (early or late) and in terms of leakage, early or late. Are Teflons any better? Not much. I may have to buy a couple to find out. ■

*RAP/Robert A. Pease/Engineer*

*to view this article online,  [click here](#)*

[Back to Table of Contents](#)



# What's All This Noise Gain Stuff, Anyhow

*Originally published February 2004*

**O**n my recent seminar tour, I asked about 4000 engineers, “How many of you use noise gain?” About 2% of the people held up their hands. Sigh. Noise gain is often not very important or critical. That is one of the reasons why op amps are so popular. They tolerate almost any kind of feedback and any noise gain. You can often see that by inspection. But when it is important, things get interesting pretty fast.

Let's start with a definition of noise gain: Noise gain is the reciprocal of the attenuation from the output of an op amp (or any feedback loop) to the input. In *Figure 1*, the attenuation is  $R_{IN}/(R_{IN} + R_F)$ . So the noise gain is  $(R_F + R_{IN})/R_{IN}$ . Or,  $(Z_F +$



## What's All This Noise Gain Stuff, Anyhow?

 $Z_{IN})/Z_{IN}$ .

As I say in my lecture, it is not a good idea to try to memorize that, because that just ensures that you will forget it. But you ought to recognize the cases where life gets interesting.

If  $Z_F$  is 100 k $\Omega$  and  $Z_{IN}$  is 1 k $\Omega$ , the noise gain will be about 100—or, technically, 101. This normally ensures that the loop is very stable because the noise gain crosses the amplifier's gain-bandwidth product at a place where there is almost never any problem (*Fig. 2a*). However, the name “noise gain” also reminds us that this really is the gain for the noise! So figure 1 is often used as a noise-test circuit. And, as noise does properly extend down to dc, if the op amp has a  $V_{OS}$  of 1 mV, then the output offset will be 101 mV!

If  $R_F/R_{IN}$  is a small number, and the noise gain is not very high, the curve of *Figure 2b* can apply. Most op amps are happy with any noise gain from 1 to 2000. But be cautious about any amplifier that is specified for “Gain of 10 minimum.” Such an amplifier has excessive phase shift at high frequencies, and it will surely oscillate if

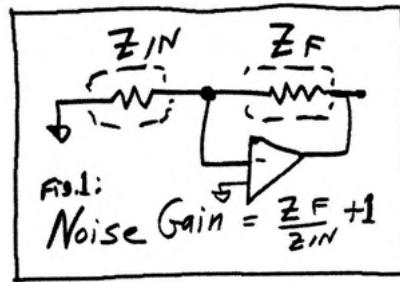

the noise gain is not at least 10 (or as stated). But, refer to NSC's App Note LB-42.

Reactances: If we add a feedback capacitor across  $R_F$ , the noise gain can be high at low frequencies, but

it will fall to 1 at high frequencies (*Fig. 2c*). Guess what? This cuts the output noise—a very popular move!

However, if your application circuit happens to have a lot of capacitance on the summing point—which might happen if you had a large photo diode or a lot of cable capacitance—then the noise gain will rise at higher frequencies. This can cause serious problems because when the noise gain rises (*Fig. 2d*), it tends to cross the op amp's gain-bandwidth product too steeply. And, the 12-dB per octave slope will cause severe ringing. This ringing or oscillation can usually be

cured with a small feedback capacitor. The nominal value for this capacitor will be  $\sqrt{2C_{IN}/(GBWP \times 2\pi R_F)}$ . For a typical circuit with a summing-point capacitance of 100 pF, the  $C_F$  may need to be 5 to 10 pF—not too huge.

Note, however, that while most of this analysis is computed in the frequency

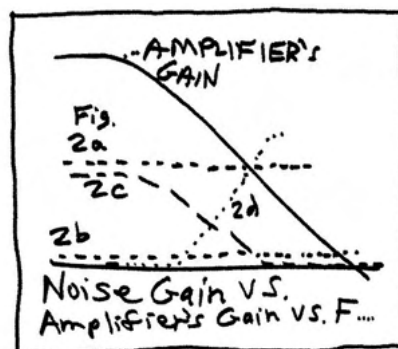

## What's All This Noise Gain Stuff, Anyhow?

domain looking at Bode plots, the evaluation of loop stability is normally done in the time domain. Hit the input with a little step of current and see how well the output settles without excessive ringing.

Often, an engineer proposes to use a “tee network” for his feedback resistance to avoid having to buy a large-value resistor. I almost always say that that’s a bad idea. Why? Because of the noise gain! Either due to the noise, or the bandwidth, or the drift, any tee network with a factor of more than 2 is usu-

ally a terrible idea. A noise gain of 10 or 100 or 1000 is often a terrible idea!

Next time you work with an op amp, think about the noise gain. If it is a simple case, it won’t require more than a moment. But if it is complicated, it might require more than an hour! Or if you neglected to study the problem properly, you’re in for days of grief! ■

*RAP/Robert A. Pease/Engineer*

*to view this article online,  [click here](#)*

[Back to Table of Contents](#)



Sep 5, 2000

# What's All This Current Limiter Stuff, Anyhow

*Originally published September 2000*

The other day I was studying a current limiter using a basic current regulator, which used an old LM317LZ (*Fig. 1*). I did the design on this IC about 20 years ago, with a little advice from Bob Dobkin. The LM317 was trying to force 40 mA into a white light-emitting diode (LED), so that 1.25 V across  $R_S$ , the 30.1-ohms sense resistor, would cause a 41-mA current to flow—if you had enough voltage. (This is a GOOD standard application shown in every LM317 data sheet.) Because the output pin is 1.25 V above the adjust pin, the current  $I = 1.25 \text{ V}/R_S$  will flow—if there's enough voltage.

It worked fine with an input voltage of 9 V, or 8

## What's All This Current Limiter Stuff, Anyhow?

V. But, of course, when it hit 7.4 V, it began dropping out of regulation. This was the basic design for a flashlight, using a white LED and a 9-V battery. The flashlight would run with  $R_S = 30$  ohms for a BRIGHT output, or 120 ohms for long battery life, and still provide enough light to hike with on a trail in the pitch dark.

I pondered this for a while. Would it do any better if I put the load in the + supply path of the LM317? How about installing the load between A and B, and placing a jumper wire between C and D? No, it would work just as well—and just as badly.

Then a few days later, I realized—I could do a lot better than that! Yes, an adjustable current source, such as an LM334N, might do a tiny bit better than an LM317. But see *Figure 2*.

The LM334N can regulate with not 1.25 V across the sense resistor—but just 64 mV. So a 1.6-ohms re-

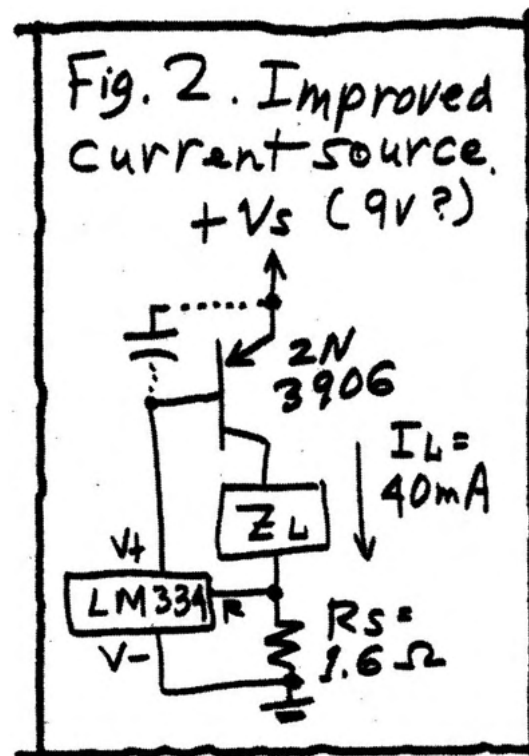
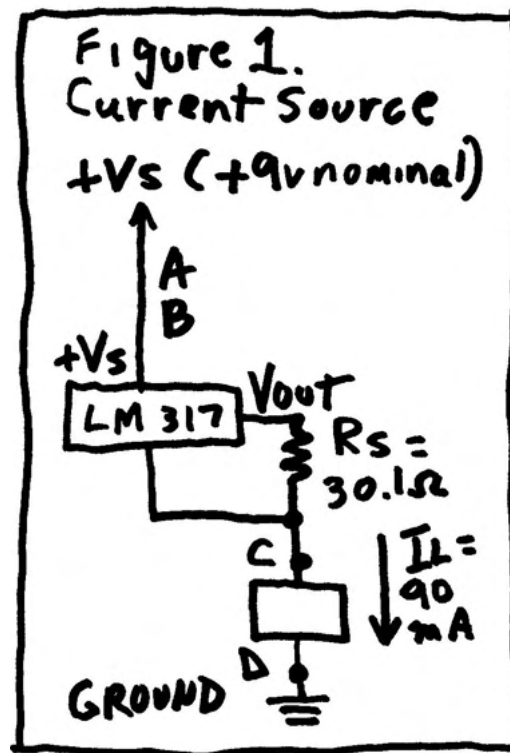

sistor will let you source 40 mA quite handily. And the voltage across the load does NOT have 0.7 V in series with it, so it regulates down MUCH better than Figure 1.

How much voltage is across the transistor? An ordinary 2N3906 will keep working down to 65 mV. So you can force 40 mA into a white LED that runs at 4.0 V, even down to a 4.13-V battery voltage. If you want to put 20 mA into a series stack of red LEDs, the conventional LM317 scheme will light two LEDs with a battery down to 6.3 V. But the LM334 scheme can drive three LEDs in series, with the same voltage. So it's not a bad circuit. This is a useful trick, especially if you have a load that's floating, and isn't grounded to either supply.

THIS circuit doesn't have a low tempco. Its output current increases

## What's All This Current Limiter Stuff, Anyhow?

at  $+0.33\%/^{\circ}\text{C}$ . But that's plenty good enough for many cases—like in a flashlight! If you need a better tempco than that, we know several ways to do it. Still, this will let you regulate the current into a red LED down to 2.1 V of supply voltage, or a white one down to 4.2 V—MUCH better than 7.4 V.

OH—I almost forgot to say—the LM334 sometimes needs a series RC damper. My first guess was  $2\ \mu\text{F}$  and 22 ohms across the base-emitter of the PNP. Actually, this circuit didn't oscillate or ring badly without an added capacitor, but the noise was a bit quieter when I added a 2- or  $10\text{-}\mu\text{F}$  electrolytic.

If you really want a low tempco, use copper wire (magnet wire) for the resistor—that will cancel out nicely. You'll need 6 ft. of #34 gauge, or 10 ft. of #32.

Even if you did have a grounded load, this circuit would regulate down to 5.4 V—considerably better than 7.4 V.

A few months earlier, I received a request for a somewhat-larger current limiter, that would pass 280 mA (200 mA ac rms) at 115 V ac, but no more than 300 mA. I thought a few seconds and scribbled out the basic circuit of *Figure 3*.

I told the guy, "This will probably work, but the FET has to be a big one, such as an IRF640 or IRF740, with a large

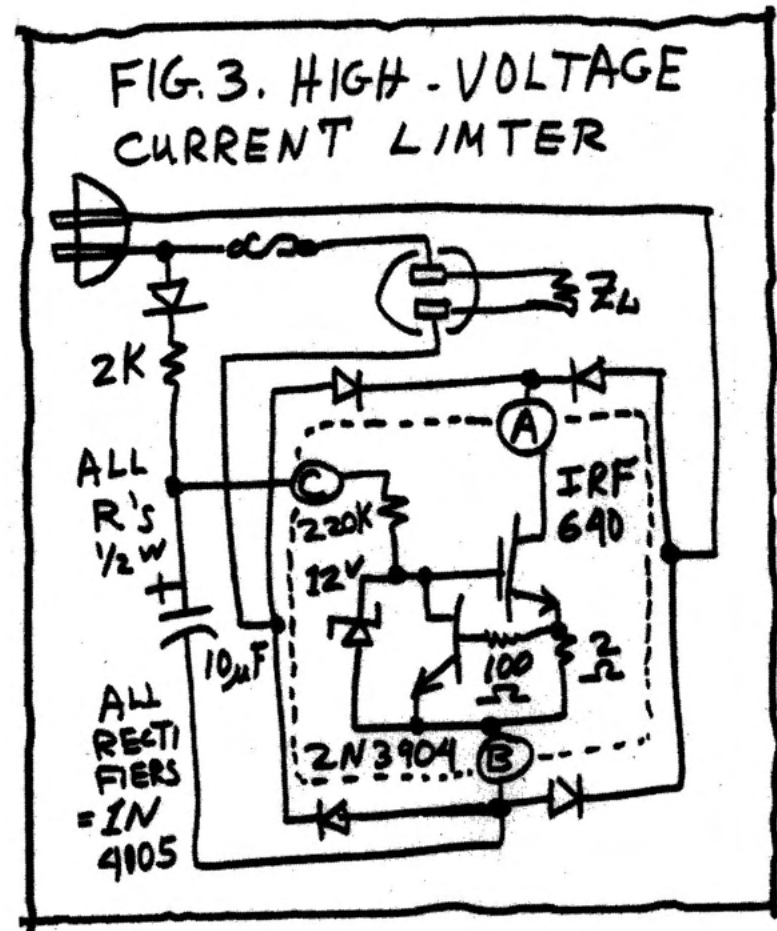

heat sink, as it will have to handle 30 W. And the current limit isn't perfectly constant, or well defined, as the current limiter gets smaller at warm temperatures. I don't know if that's what you want, but that's what you get. Tell me if that's unacceptable. And if you nail the output with a short-circuit load, it will probably blow out."

Later, I thought about this circuit. Would it be possible to design in some improvements, to avoid some of these

## What's All This Current Limiter Stuff, Anyway?

disadvantages?

When a shorted load is applied, the drain-source voltage will rise instantly to +150 volts, and the gate-drain capacitance will try to pull the gate to +130 V. That's not so good! Maybe the  $10\ \mu\text{F} + 0.1\ \mu\text{F}$  across the zener, with the Schottky diode D2 added, will help clamp the gate to +15 V well enough to survive a momentary short? (Fig. 4.)

The temperature coefficient problem gets solved next. The  $V_{BE}$  shrinks at  $0.3\%/^{\circ}\text{C}$  in Figure 3. But the improved circuit of Figure 4 gets a better tempco of the current limit, by compensating for that  $V_{BE}$  tempco with the tempco of the Schottky rectifier D3.

While this will provide a good current limit with well-behaved loads, it may not turn on the 2N3904 quickly enough with severe loads. So I added the little diode D4. This will give a short-term current limit at perhaps 1 A, which will rapidly fall to 0.3 A.

Now how about the long-term current limit, in case of a short? That FET is going to get HOT!

Well—why don't I add R6 and R7? Normally, the voltage across the FET is less than 0.1 V. When it goes into current limit, and the voltage across the FET increases toward 100 V, the current through R7 requires the current-limit

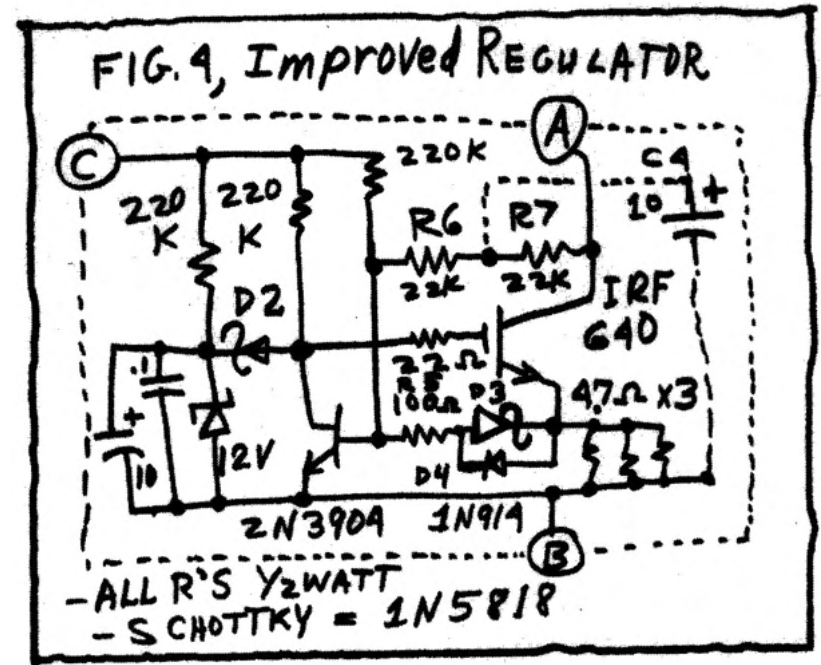

voltage across R5 to decrease. So in case of a short, or a very heavy load, the current limit folds back, and the heat in the FET decreases. That sounds pretty good. But what if you need to start-up a heavy load? That current through R6 would prevent the limiter from starting in case of filament inrush current, or filter capacitors that need to be charged.

Well—let's add one more Band-aid. Let's add C4. This will let the limiter put out a LOT of current for a short time, for start-up. How much power loss? At 0.3 A, the burden (IR drop) is only 0.4 V for the limiter circuit, plus 1.2 V for the rectifiers.

Well—that sounds like a good theory. Does it work? Let's see. When I draft-



## What's All This Current Limiter Stuff, Anyhow?

ed this, I hadn't yet built this. But I felt it was well engineered, so I wasn't too surprised that it really did work as designed, when I built it.

I evaluated it very gingerly with light loads, moderate loads, full loads, and overloads. I ran it on a curve-tracer, and turned up the voltage very carefully. When I saw that it met every requirement, I dropped a short across the load. The curve tracer grunted, but the regulator survived.

Then, I plugged that circuit into the WALL and applied all kind of loads. After it survived every test, I shorted the load again. I was pleased to see that it ran cheerfully, it survived, and it didn't get very hot.

**DISCLAIMER:** Kids, DON'T just try this at home. Working with high voltages can be lethal if you get sloppy. When working on this circuit, turn the power OFF and unplug the cord. If possible, use an isolation transformer. Additionally, use a variac so you can turn up the voltage gradually when starting out. Wear safety glasses for all high-voltage testing. Keep one of your hands in

your pocket when actually working on the circuit, to prevent a loop that could send lethal currents through your chest. Be careful of high voltages. If possible, work on this ONLY when somebody is around to give you first aid and call a medic, in case of shock or explosion. This high-voltage circuit is NOT guaranteed for anything. It does NOT come with a guarantee of some safety margin. Plus, it hasn't been evaluated with any loads other than resistive. Still—it' s a pretty good place to start. /rap ■

*RAP / Robert A. Pease / Engineer*

P.S. The last time I designed such an "electronic fuse," it blew up the FET three times in a row when I applied a short. I then gave up. This design seems to work much better. But if I keep decreasing the sense resistor by 3 dB at a time, I wonder how far up the current limit can go before it starts blowing up! But I'm not going to look at that tonight!

*to view this article online,  [click here](#)*

[Back to Table of Contents](#)



# Part 1: What's All This Output Impedance Stuff, Anyhow

*Originally published August 2008*

A few engineers were having a debate. According to all the books, some of them said, op amps are supposed to have zero output impedance, or very low. That means the output voltage won't change, just in case the output current changes. Some older op amps had an output impedance of  $600\ \Omega$  or  $50\ \Omega$ . So, the gain of the amplifier won't change just because the load changes. That must be good.

But a couple of other engineers pointed out that many modern op amps have a very high output impedance. The advantage of high output impedance (for the op amp) is that when the load gets lighter, the gain goes up. Is there any

## Part 1: What's All This Output Impedance Stuff, Anyhow?

harm in having a higher gain?

Sometimes it's advantageous to have high gain, and higher gain isn't necessarily bad. This high output impedance usually occurs on rail-to-rail outputs, which are "drain-loaded." You can't have an emitter-follower or source-follower output on a rail-to-rail output! If you did, it wouldn't swing rail-to-rail.

### A FOOLISH IDEA

Let's have a little more insight on this gain stuff. "Nobody needs an op amp with gain higher than 200k," I once heard one foolish engineer say. "Besides, nobody would want to measure an op amp's gain at 2 million or 6 or 10 million, because it would take many seconds of test time, at 0.1 Hz or slower, and nobody wants to pay for that test time."

Wrong! We can test op amps for a gain of 1 million or 10 million in just a few dozen milliseconds. We read the summing-point voltage, put in a suitable step, and wait a couple milliseconds for the summing-point voltage to

**If an op amp can't put out much current, no matter how you try, then it won't have good performance when you ask it to drive heavy load currents.**

settle. Then we wait a few milliseconds more, read the changed voltage, and average for a few milliseconds more (perhaps for 16 ms).

The voltage gain is related to the reciprocal of those few microvolts of error. We measure gain for a step, not for sines. So does everybody else in the industry. The settling time is related to the amplifier's gain bandwidth, not to its low-frequency "pole," which is just a fiction.

This same guy argued that when you use an op amp with a gain of 2 million or 10 million, "You can only see higher accuracy when you have signals well below 1 Hz." Wrong again! If you put in a +1-mV square wave at 10 Hz into a good op amp set up with feedback resistors for a gain of +1000, the amplifier with 2M will settle in a few milliseconds to 999.5 mV.

The output for the gain of 20M will settle to 999.95 mV. If you had a gain of just 200,000, it would settle to 995 mV. Even with sine waves at 10 Hz, you can see the difference in better gain accuracy. The output would be 999.5 mV or 999.95 mV p-p, not 995 mV p-p, even at

## Part 1: What's All This Output Impedance Stuff, Anyhow?

10 Hz! Higher gain is better.

## A SECOND OPINION

---

“If an op amp has a high gain at rated load, and its output impedance is high, then the gain gets higher when the rated load is taken off,” another engineer argued. “The dc gain goes up, and then the gain rolloff will be steeper, and you’ll get more phase shift, which will make the loop less stable.”

Well, I haven’t seen any op amps whose rolloff gets steeper when the rated load is taken off, not for 35 years—an amplifier whose phase-shift goes bad. All modern op amps have Miller feedback from the output, so when the gain gets higher, the low-frequency break just goes back even further—even slower than 0.01 Hz. I’ve seen that a lot. So, there’s no danger there if the gain gets “too high.” A gain of 1M or 10M or 100M does no harm.

What is an example of an op amp where the gain goes up when the rated load is taken off? A lot? The LMC662 or the LMC6482. These are CMOS amplifiers with ~ “rail-to-rail” output capability. Of course, it makes a difference how the output is controlled.

If there is a Miller integrator (capacitive feedback loop around the output

stages) to make the gain rise smoothly at low frequencies, that can make the gain smooth indeed. The gain could rise smoothly at 6 dB per octave, even back below 1 Hz or 0.1 Hz.

Okay, where is the proof of the pudding? What does the gain look like? What does it do for a closed-loop gain of 10? More in the next issue!

The real performance of an op amp driving a load is also related to the  $g_M$ , or transconductance. If an op amp can’t put out much current, no matter how you try, then it won’t have good performance when you ask it to drive heavy load currents. That’s generally true if the ZOUT is high or low. You gotta have some  $g_M$ . (As the old trucker used to say, you can’t climb hills with paper horsepower.)

Let’s look at examples of both types. If the load is lowered, does it hurt the gain accuracy? The distortion? If the load is lightened, does it hurt the gain accuracy? The distortion? The settling time? In the next column, we will put these questions to the test using the test circuit shown for the “best” amplifier of 2006 ■

*RAP/Robert A. Pease/Engineer*

to view this article online,  [click here](#)

[Back to Table of Contents](#)



# Part 2: What's All This Output Impedance Stuff, Anyhow

*Originally published August 2008*

**W**hen I present seminars, I often ask the members of the audience to hold up their hands if they think bipolar op amps have better gain and linearity than CMOS. I get a good majority of hands. But neither is bad!

The good-old LM301A (well over 30 years old) has a good gain of 260,000 at no load, with just 75  $\mu\text{V}$  p-p of gain error while its output is swinging 20 V p-p (*Fig. 1*). What happens when we put on a load? With its rated 2k load, the gain falls and even reverses a little and becomes nonlinear in its error.

The lower curve shown here (with a 1k load



## Part 2: What's All This Output Impedance Stuff, Anyhow?

**1. Crossplots of gain error, with test circuit per AN-1485: LM301A, F= 5 Hz; output  $\pm 10$  V into 1 k $\Omega$  (lower trace); upper trace, 75  $\mu$ V p-p at 100  $\mu$ V/div.; lower trace., 48  $\mu$ V p-p at 100  $\mu$ V/div.**

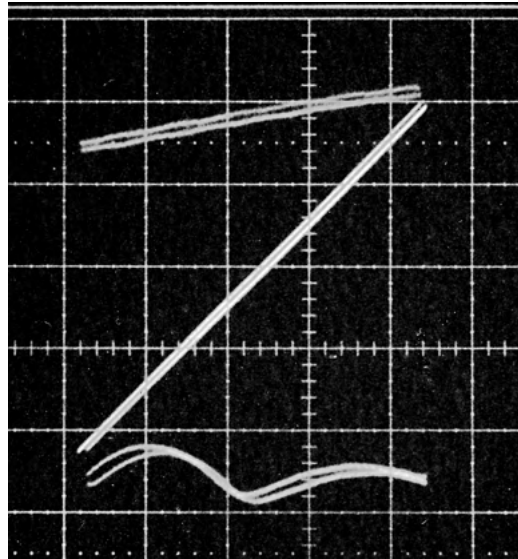

to exaggerate the error) shows that the LM301A's nonlinearity becomes as big as 48  $\mu$ V p-p. This isn't due to low "gain" or gM, but to thermal feedback from the output transistors to the input transistors, which is caused by imperfect layout of the temp-sensitive input transistors.

Well, this does look lousy, but there are mitigating factors. This thermal effect is most obvious at 0.2 to 20 Hz. At frequencies above 150 Hz, this effect tends to go away and smear out, and at 1 kHz, you can hardly see it. So, this isn't a big problem for audio amplifiers.

Also, if the amplifier isn't driving heavy load currents, this thermal problem shrinks proportionately. At light loads, it's negligible. Even with a 4k load,

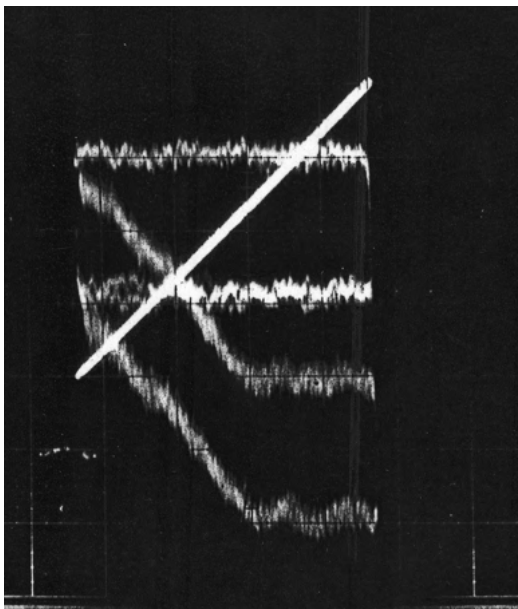

an LM301 can make a unitygain inverter with a nonlinearity of 1.2 ppm. At lighter loads, it's even better.

## ON THE BENCH

Now let's look at some CMOS amplifiers with ~ rail-to-rail outputs. The LMC662 is typical—one of our first CMOS amplifiers (*Fig. 2*). Like the LM301A, its gain degrades when overloaded with 1 k $\Omega$ . But the nonlinearity (deviation from best straight line) is only 18  $\mu$ V p-p. That's not bad for an 8-V, 8-mA p-p swing.

This isn't thermal cross-talk, just a matter of honest gain. The LMC662 has four honest gain stages to source current, but just three stages to sink load current. Still, its high output impedance causes the gain to rise a lot when lightly loaded. How high

**2. LMC662, F = 6 Hz; output  $\pm 4$  V into 1 k $\Omega$  (lower trace); upper trace, 1  $\mu$ V p-p at 10  $\mu$ V/div.; lower trace, 27  $\mu$ V p-p at 10  $\mu$ V/div.**

## Part 2: What's All This Output Impedance Stuff, Anyhow?

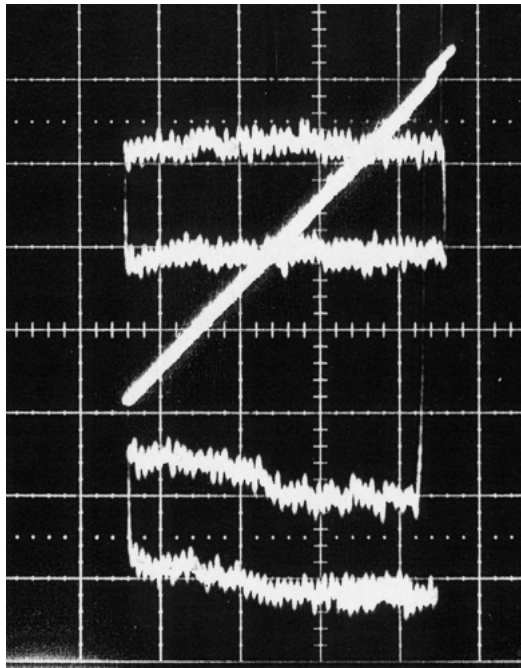

3. LMC6042,  $F = 0.6$  Hz; output  $\pm 4$  V into  $1$  k $\Omega$  (lower trace); upper trace,  $2$   $\mu$ V p-p at  $20$   $\mu$ V/div.; lower trace,  $6$   $\mu$ V p-p at  $20$   $\mu$ V/div.

does it rise? Well, it seems to rise higher than 4 million, but the error is down in the noise. As with the LM301A, its distortion when driving a 4k load is about 1.2 ppm.

So, it really is possible to get low distortion with ordinary op amps. And, it's easy to get exquisite linearity with good, inexpensive amplifiers. For example, the LMC6022 does better than 0.3 ppm (*Fig. 3*). That's pretty good for a micropower op amp. Its open-loop ZOUT is above a megohm, but its closed-loop ZOUT is below a milliohm! ■

*RAP/Robert A. Pease/Engineer*

to view this article online,  [click here](#)

[Back to Table of Contents](#)

# GET MORE IDEAS AND SOLUTIONS FROM **ELECTRONIC DESIGN** NOW!

*From the start of your design idea, sketched as a schematic on a napkin, through to the ordering process for prototypes and final production ...*



*Electronic Design* is the design engineer's trusted online resource.

If you like the content of this eBook, you'll love what we have for you on the websites!  
*Go to next page to see what we offer!*

**Electronic  
Design.**



# CHECK OUT THESE RESOURCES FROM ELECTRONIC DESIGN AND OUR SISTER BRANDS

## WEBSITES

**Electronic Design** **Microwaves & RF**

**sourceesb**

**Power Electronics**

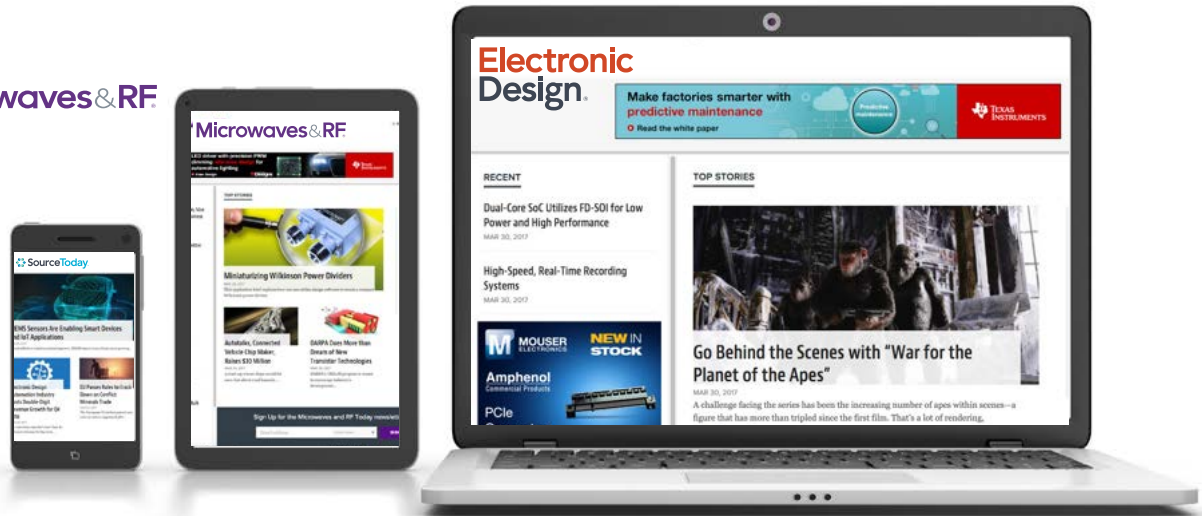

## MAGAZINES

You can also apply for a subscription to one of our traditional magazines available in both print and digital formats.

**ELECTRONIC DESIGN – complimentary in US and Canada -  Subscribe Now**  
*Non-qualified or Outside the US and Canada:* you will be prompted to pay based on your location.

**MICROWAVES & RF – complimentary internationally-  Subscribe Now**  
*Non-qualified:* you will be prompted to pay based on your location.



## NEWSLETTERS

Stay current with the industry with newsletters created by engineers and editors with inside connections! You'll find coverage on a wide variety of electronics technologies from Analog & Mixed Signal to Embedded and more.

 **Click Here** to check out what more than 200,000 engineers are reading now.



## ABOUT US

Going strong since 1962, *Electronic Design* is the premier information source for electronics engineers. We provide must have, fully comprehensive coverage of the electronics industry through a vast network of experts. *Electronic Design* covers the technologies required for engineers to make the right design decisions at the right time – quickly and efficiently.

